

Horizontal bracket 535mm

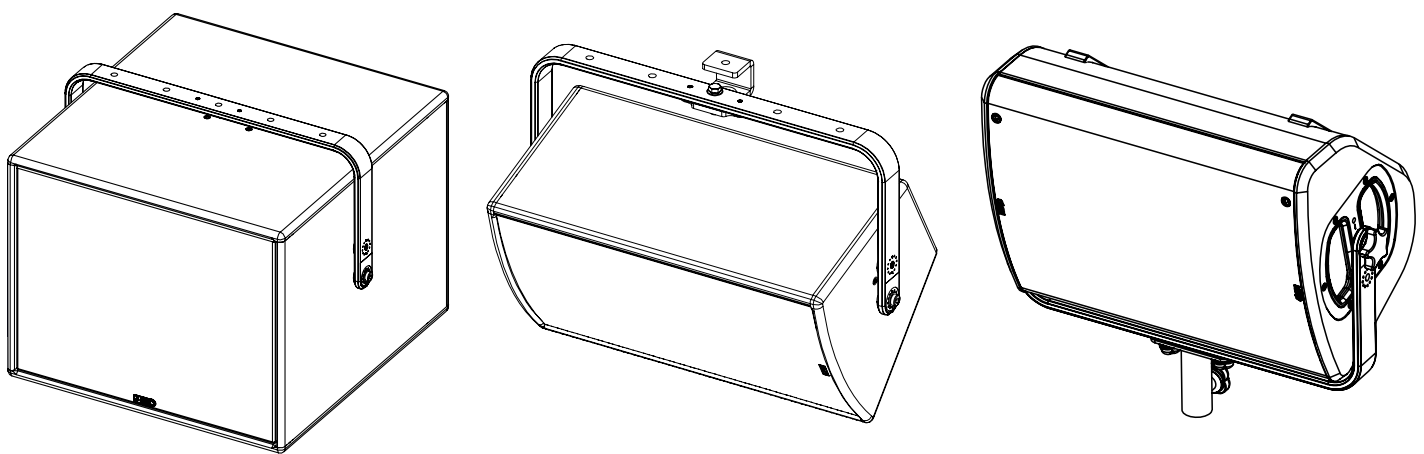
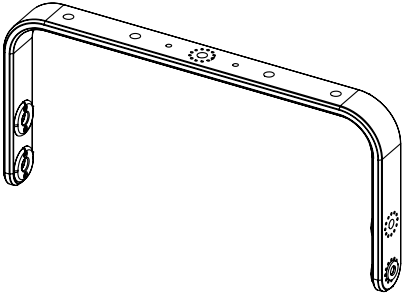
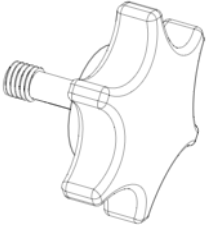
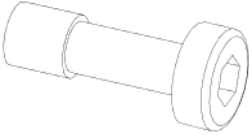
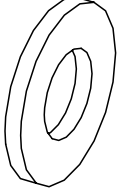

Contents:

 <p>X1</p>	 <p>X2 KNOBM10-P3783</p>	 <p>X2 VXTCHC-P4499 M10x30</p>	 <p>X2 VRA10N</p>
--	---	--	--

Weight: 1.5 kg / 3.3 lb

Dimensions:

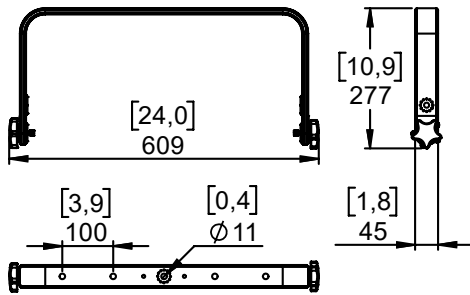

Safety

For permanent installation, use the provided thread lock coated screws.
Please, select screws and mounting location supporting 4 times the system weight.
Inspect bolted assemblies periodically.

Use:

Place HBRK535 on P12 or ePS10, use only fasteners provided. Tight properly.

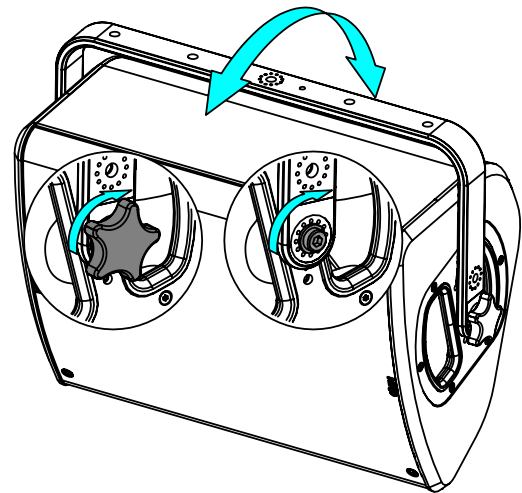
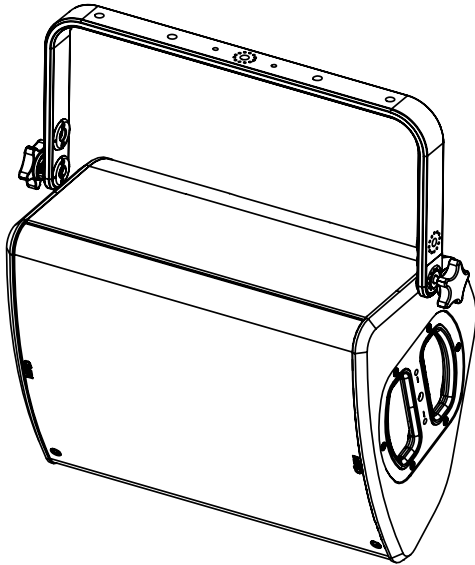

Place HBRK535 on eLS600 (2 positions), use only fasteners provided. Tight properly.

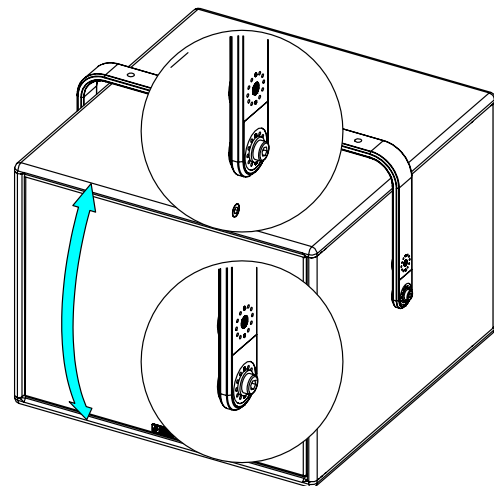
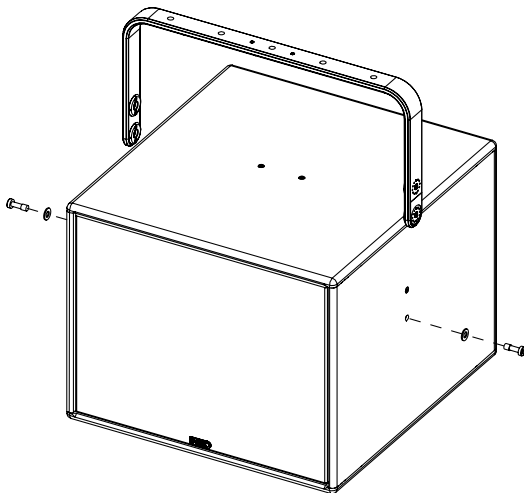

Usable with VNI-CLADAPT / VNI-WMxxx / VNU-PLADAPT

- NEXO cannot accept responsibility for accidents caused by any factor other than defects in this product itself.
- Please check the web site nexo-sa.com for the latest update.

NEXO

nexo-sa.com
ZA du Pre de la Dame Jeanne
60128 PLAILLY - France

- Read this document before using.
- Keep this document.
- Observe all warnings and cautions.

