

Coupler ePS8 – eLS400

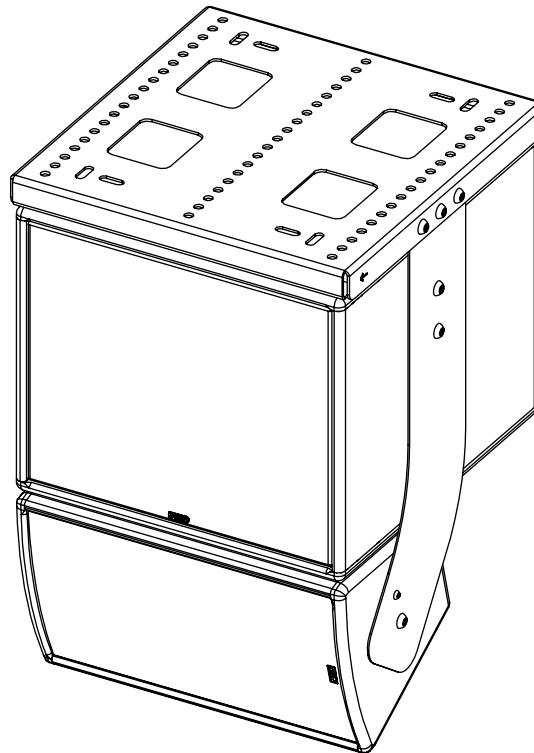
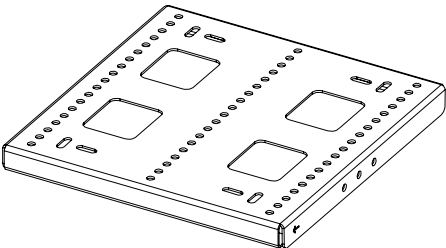
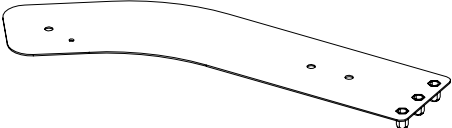
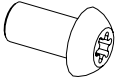
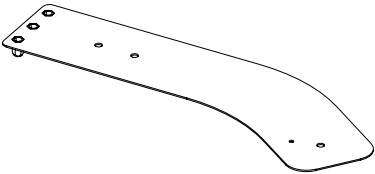
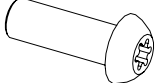
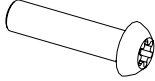

Contents:

<p>X1 Top Frame</p> 	<p>X1 Left Plate</p> 	<p>X6 M10x20</p> 
	<p>X1 Right Plate</p> 	<p>X6 M10x30</p> 
		<p>X2 M6x25</p> 

** The type of the screws may differ from the representation

Weight: 8.5 kg / 18.7 lb

Dimensions

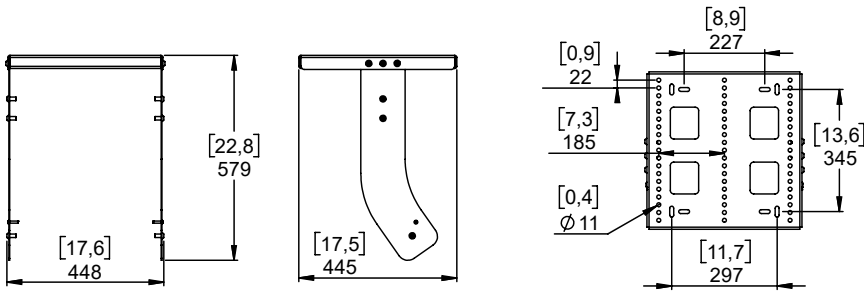

Warnings

Ensure that the mounting location and fasteners can support at least 4 times the weight of all the installed cabinets, auxiliary equipment and cables.

Use only the provided screws (thread lock coated) and accessories.

Assembly

Remove the screws on both sides.

Assemble the Plates on each side of eLS400 using the M10x20 screws.

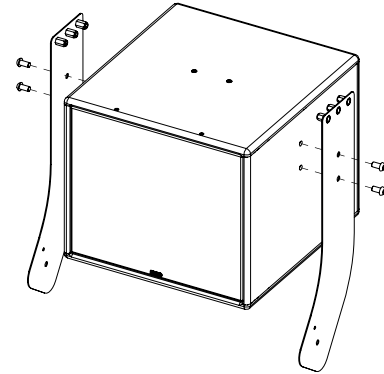
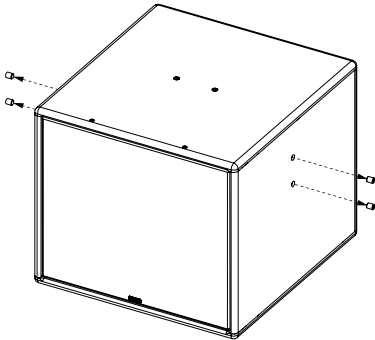

Place the assembly below the frame plate. Pay attention to the mounting direction, see the mark on the top frame. Fasten the M10x30 screws.

Remove the screws on both sides of ePS8.

Place ePS8, fasten with M10x20 and M6x25 screws.

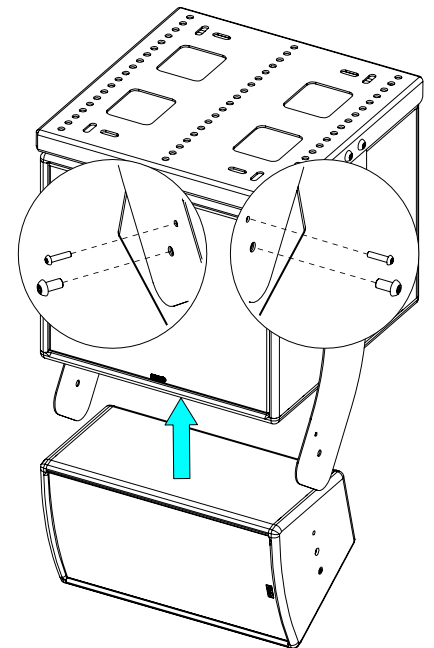
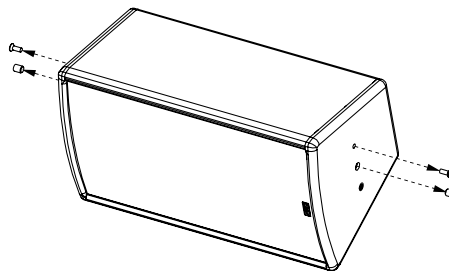
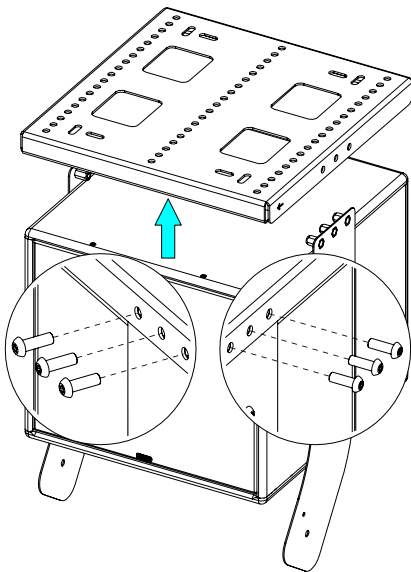

Hole*	1	2	3	4	5	6	7	8	9	10	11	12	13	14	15	16	17	18	19
Angle (+/- 1°)	+29	+27	+25	+24	+20	+16	+13	+9	+4	0	-4	-8	-12	-17	-20	-24	-27	-31	-36

*From the front of the cabinet

- NEXO cannot accept responsibility for accidents caused by any factor other than defects in this product itself.
- Please check the web site nexo-sa.com for the latest update.

NEXO

nexo-sa.com
ZA du Pre de la Dame Jeanne
60128 PLAILLY - France

- Read this document before using.
- Keep this document.
- Observe all warnings and cautions.

