

PS R2シリーズもしくはGEO S12システムのスピーカーを吊り下げるための固定設備用の金具です。

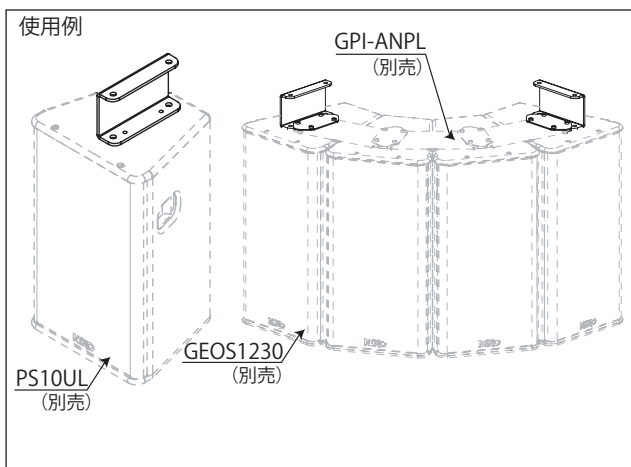

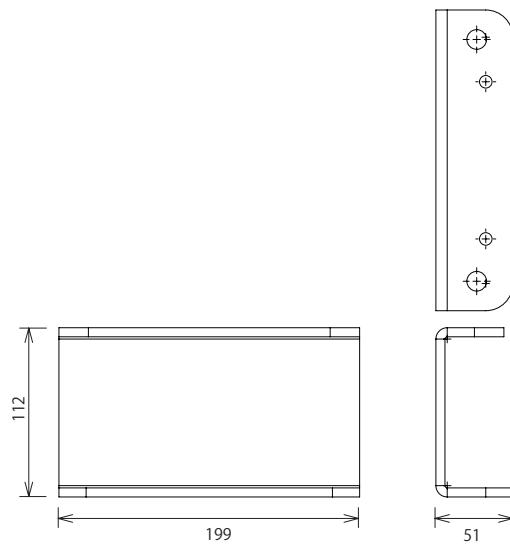







●一般仕様

適合スピーカー	PS10U L, PS10U R, PS15U L, PS15U R, GEO S1210, GEO S1230		
仕上げ	素材: Steel 700 N/m ²	色:黒(マンセルN1.5近似色)	フィニッシュ: 艶消塗装
付属品	下図 (本体及び付属品一覧) 参照		
寸法 (W x H x D)	119 x 112 x 51 mm		
質量	1.8kg		

●外観図



本体及び付属品一覧

 x1	 x1	 x2 M6D8x12	 x2 M6D8x20
 x2 M8	 x2 M6x25	 x2 M6	 x2 M12x35
 x4 M12	 x2 M12		