

3 Columns Top Coupling Bar

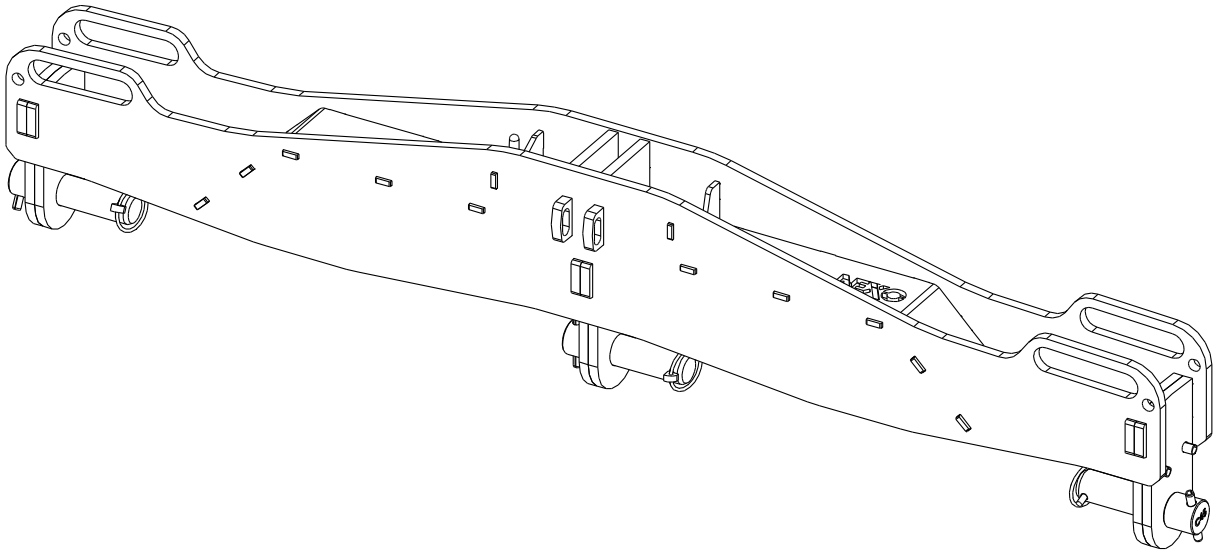

Contents:

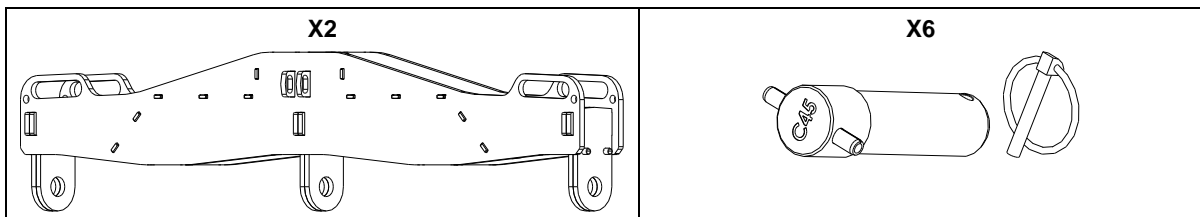

Weight: 34 kg / 75 lb

Dimensions:

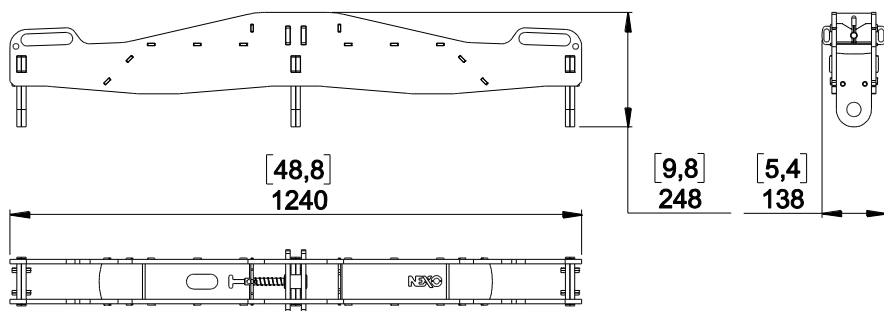

Use:

- Insert coupling beam XCOUP3 into left and right XBOWs, then lock these 2 components by inserting the steel pins into the corresponding holes.
- Insert safety pins into steel pins hole and lock safety by rotating its ring around steel pin.

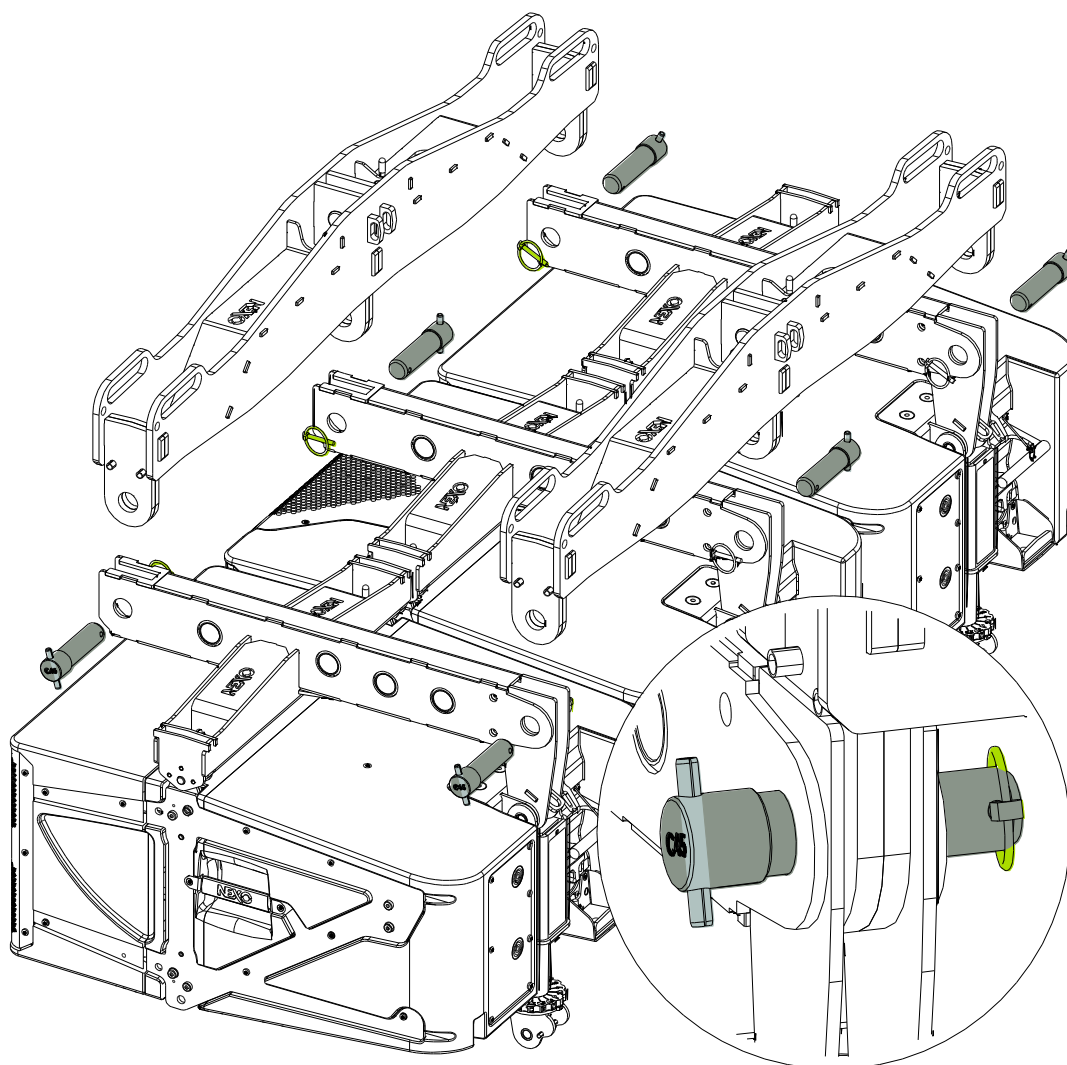

ENSURE PINS ARE PROPERLY AND SAFETY LOCKED

- NEXO cannot accept responsibility for accidents caused by any factor other than defects in this product itself.
- Please check the web site nexo-sa.com for the latest update.

NEXO

nexo-sa.com
ZA du Pre de la Dame Jeanne
60128 PLAILLY - France

- Read this document before using.
- Keep this document.
- Observe all warnings and cautions.

