

LiftBar for PLUS series

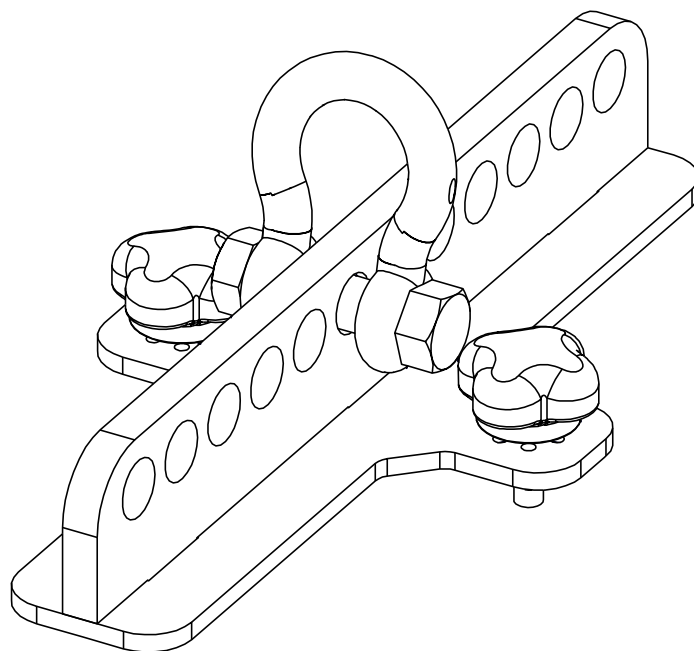
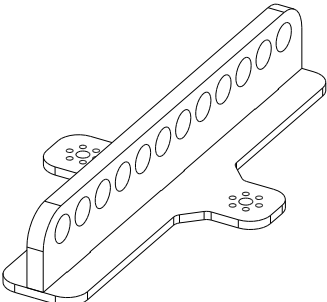
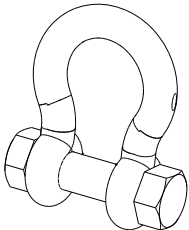
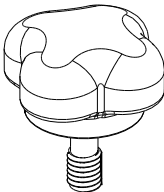
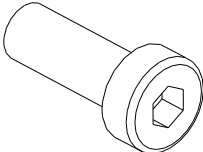

Contents:

<p>X1</p> 	<p>X1</p> 	<p>X2</p> 	<p>X2</p> 
--	---	--	---

Weight: 1 kg / 2.2 lb

Dimensions:

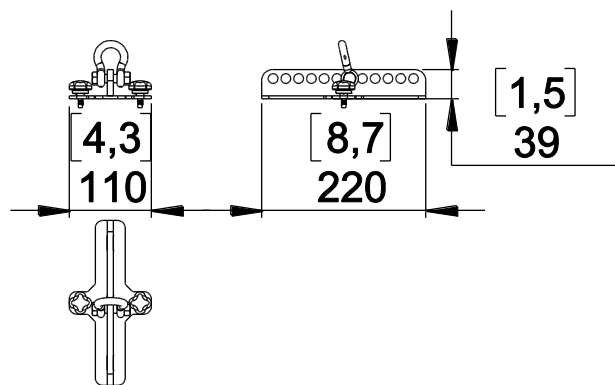

Use:

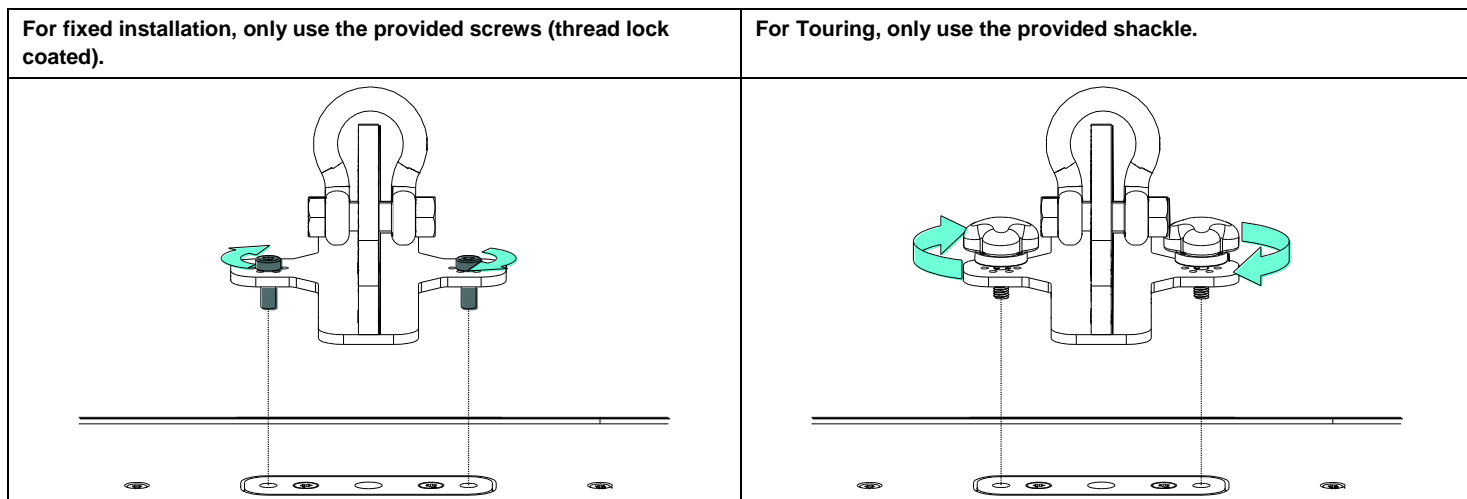

Operating locations:

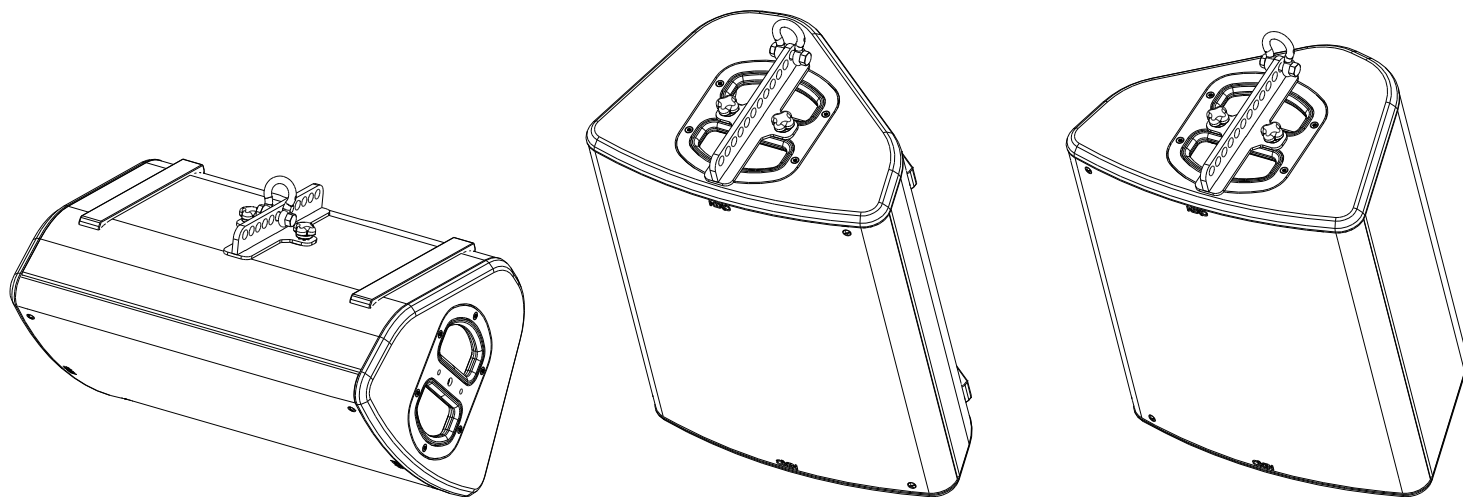

Use shackle model: Alloy Bolt Type Shackle 1 tons

- NEXO cannot accept responsibility for accidents caused by any factor other than defects in this product itself.
- Please check the web site nexo-sa.com for the latest update.

NEXO

nexo-sa.com
ZA du Pre de la Dame Jeanne
60128 PLAILLY - France

- Read this document before using.
- Keep this document.
- Observe all warnings and cautions.

