

Up to 3xL18 Rigging System

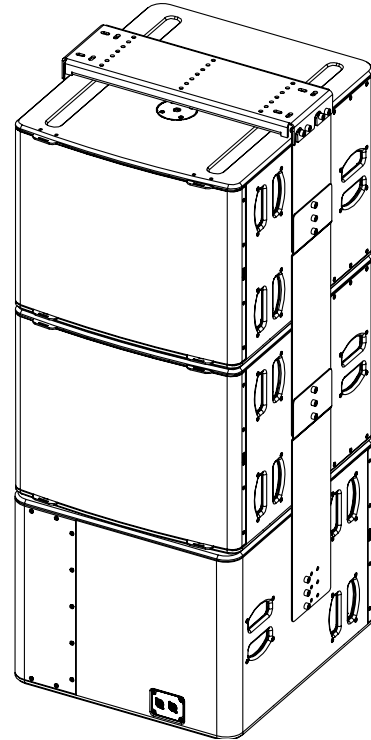

Contents:

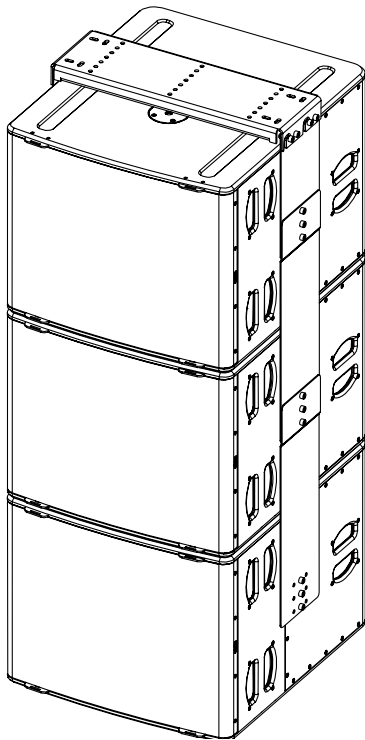
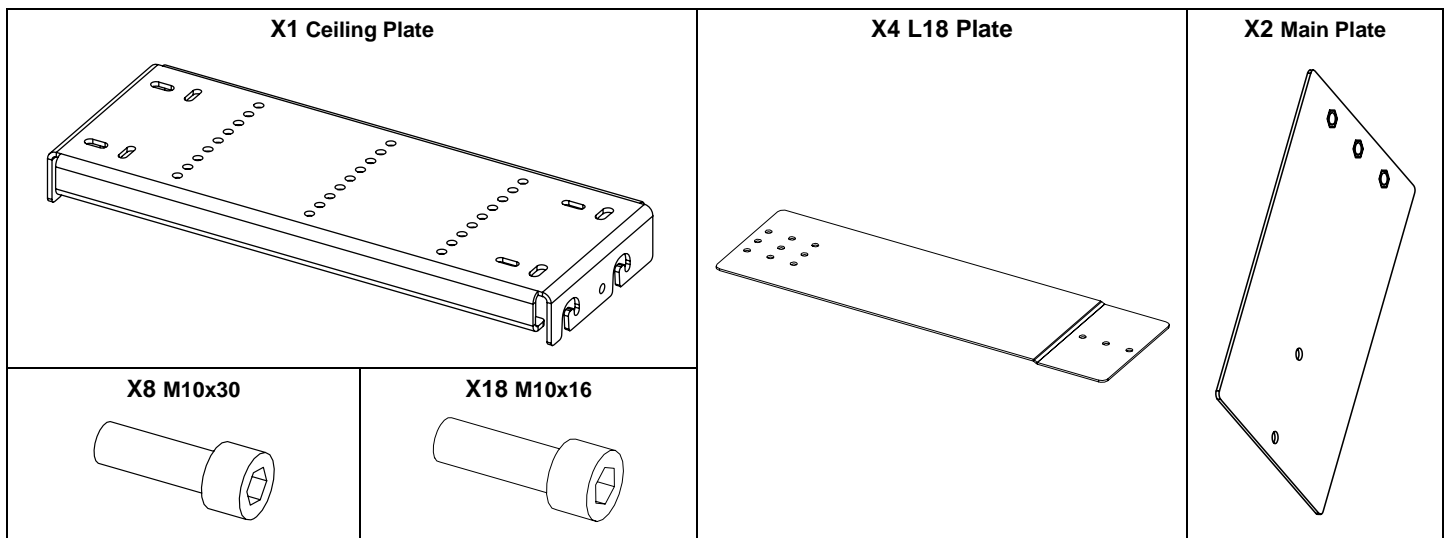

Weight: 26.5 kg / 58.5 lb

Dimensions:

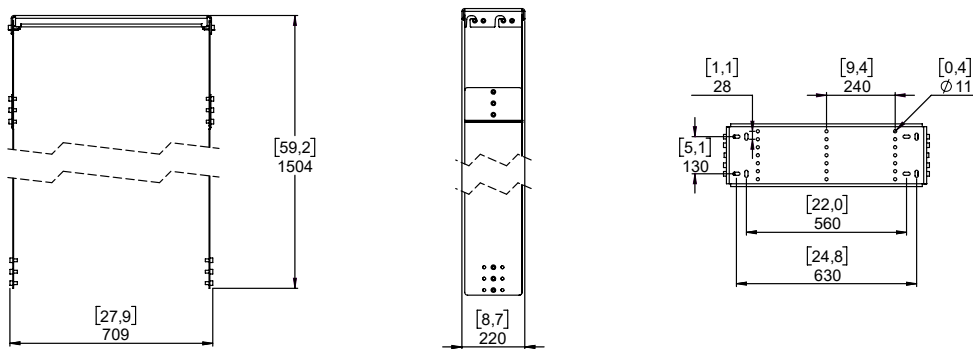

For fixation, you have the choice between M8 and M10

WARNINGS

Ensure that the mounting location and fasteners can support at least 4 times the weight of all the installed cabinets, auxiliary equipment and cables.

Use only the provided screws (thread lock coated) and accessories.

Implementation of L18

Prepare the Main plates by screwing the M10x30 screws on the holes (see picture below), do not tighten completely and leave at least 6mm.

Assemble the L18 Plates on each side of L18 using the M10x16 screws.

CARDIO mode

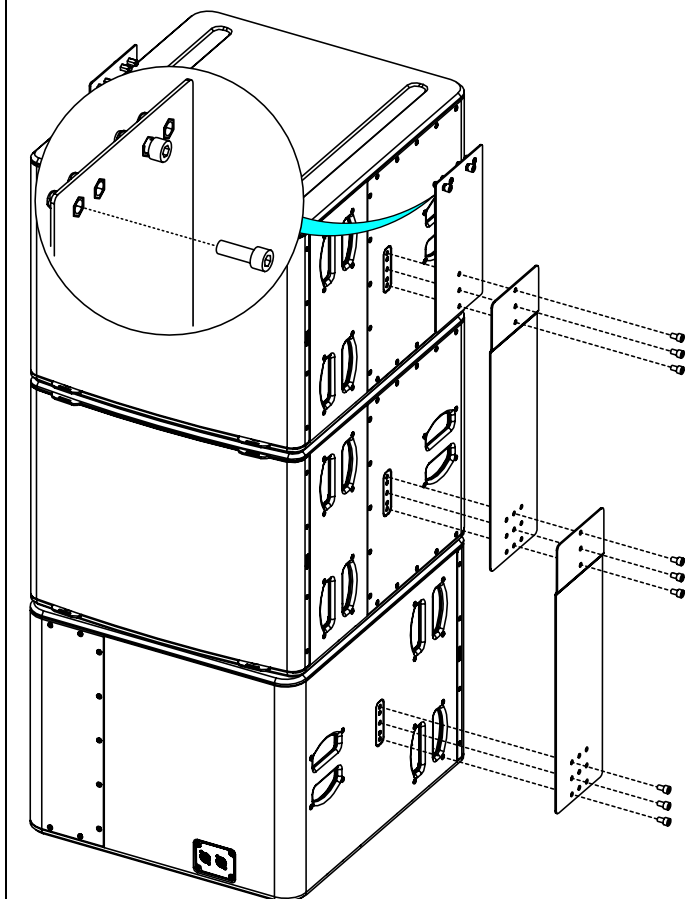

OMNI Mode

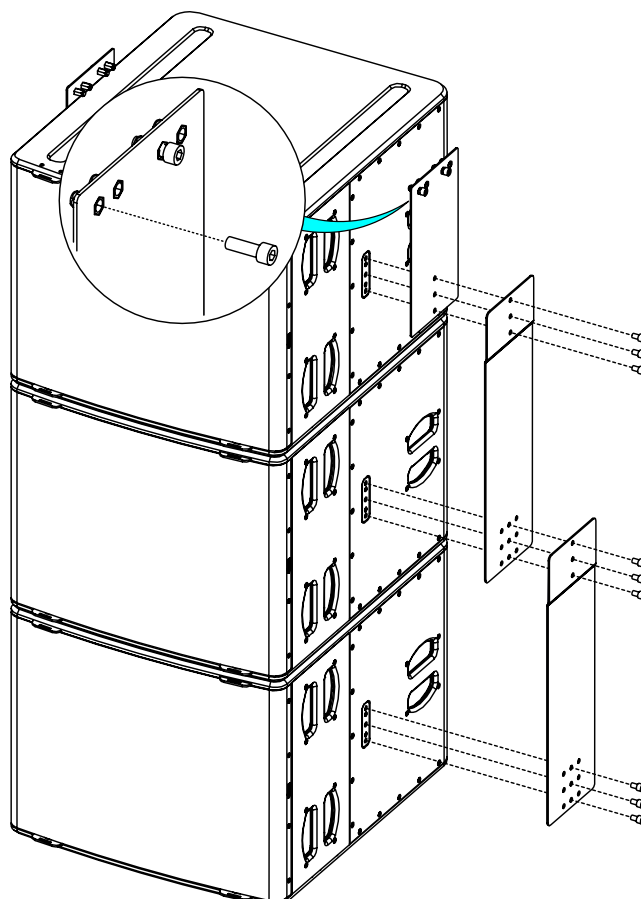

nexo-sa.com
 ZA du Pre de la Dame Jeanne
 60128 PLAILLY - France

- Read this document before using.
- Keep this document.
- Observe all warnings and cautions.



Assembly on the ceiling plate

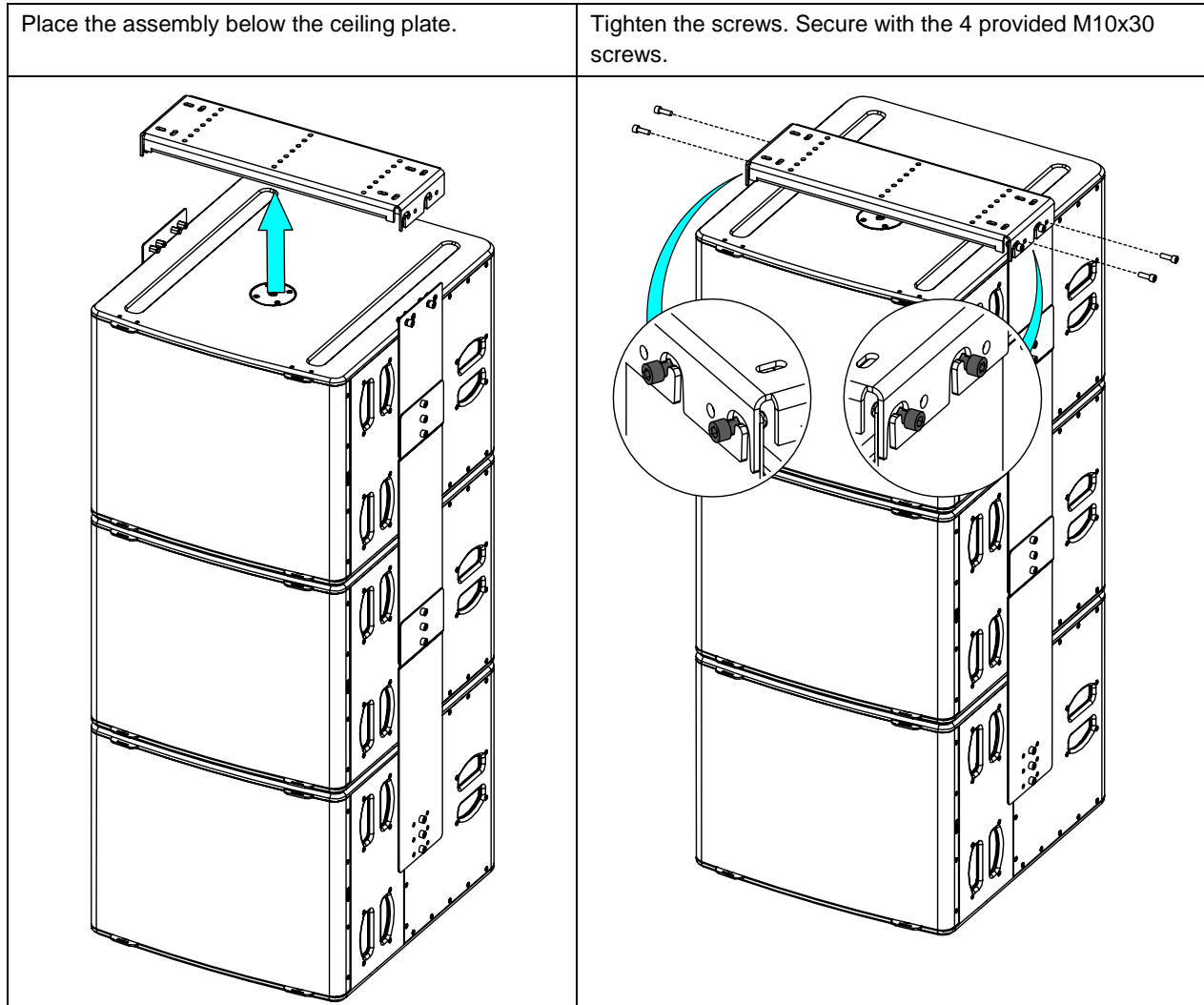

NEXO

nexo-sa.com
ZA du Pre de la Dame Jeanne
60128 PLAILLY - France

- Read this document before using.
- Keep this document.
- Observe all warnings and cautions.



- NEXO cannot accept responsibility for accidents caused by any factor other than defects in this product itself.
- Please check the web site nexo-sa.com for the latest update.

NEXO

nexo-sa.com

ZA du Pre de la Dame Jeanne
60128 PLAILLY - France

- Read this document before using.
- Keep this document.
- Observe all warnings and cautions.

