

Fixed Bumper

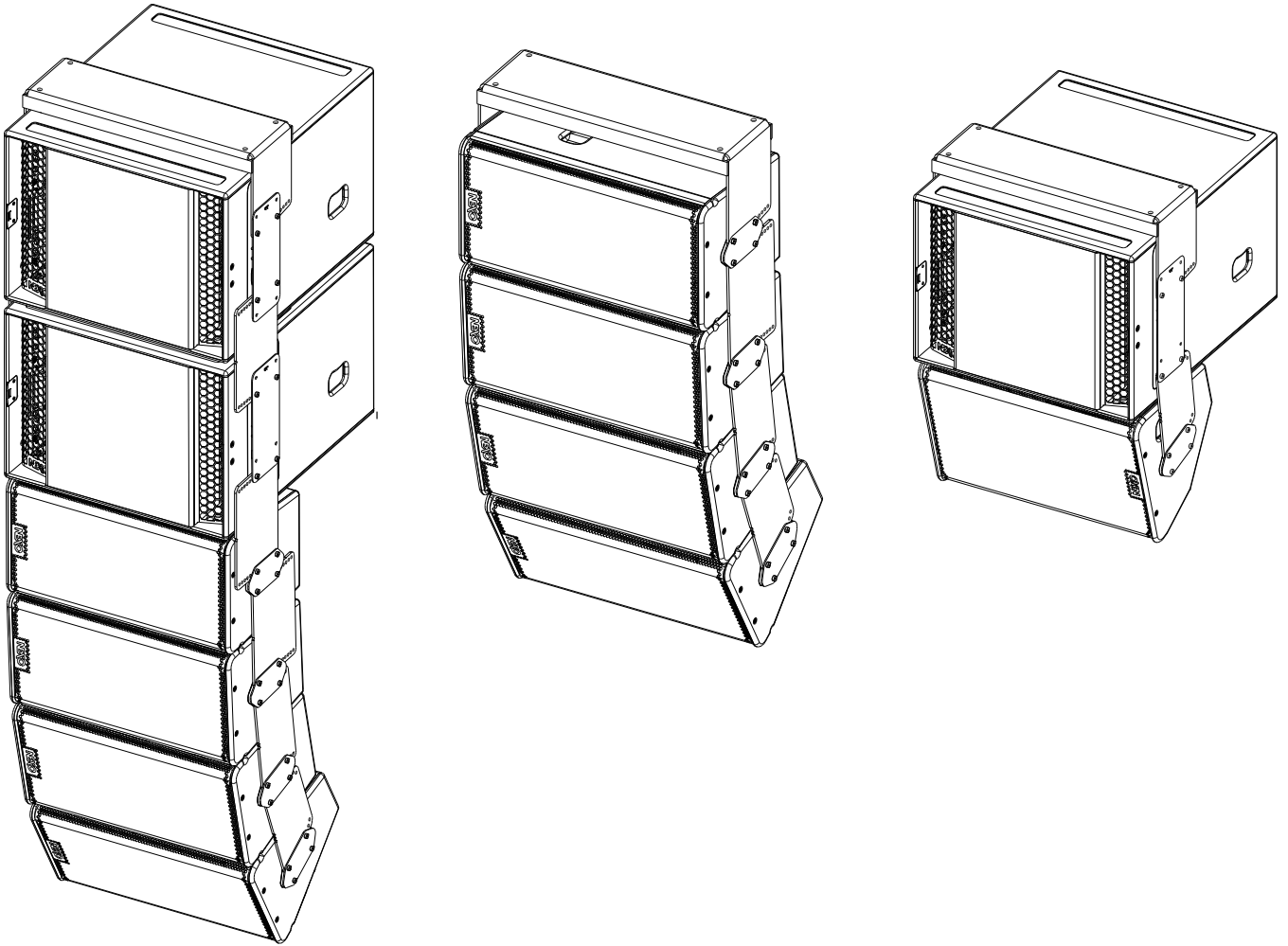

Contents:

X1

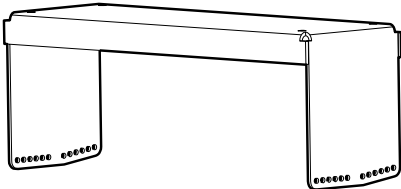

X4 (CPLA)

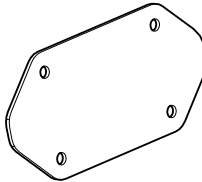

X8 (D8x20 M6)

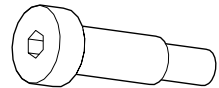

Weight: 14.5 kg / 32 lb



nexo-sa.com
ZA du Pre de la Dame Jeanne
60128 PLAILLY - France

- Read this document before using.
- Keep this document.
- Observe all warnings and cautions.



Dimensions:

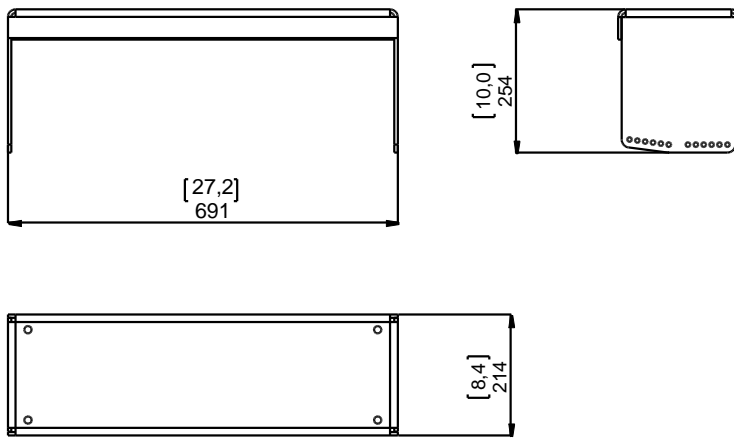

Angles:

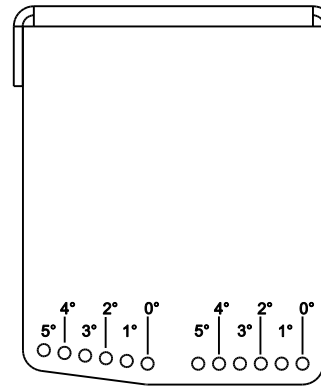

Assembly:

- 1) Remove the 4 Torx Screws holding connector plate, and replace with CPLA.
- 2) Depending on the direction of assembly, you can have a positive or negative tilt.
- 3) Insert Bumper (adjust the angle), CPLA (and/or LSI-CPLA), and tighten.

Tightening torque: 5 N.m

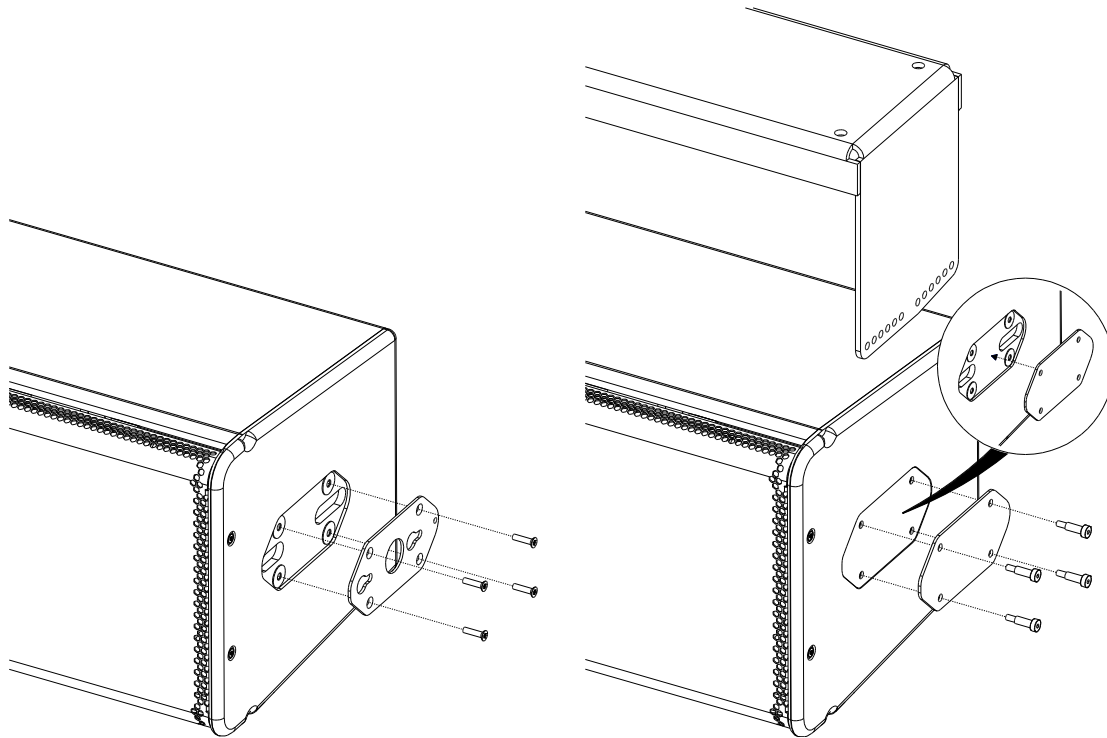

Warning:

- Use only provided screws (thread lock coated or use Loctite 243).
- Be sure that the mounting location and fastener can bear at least 4 times the weight of the of all installed cabinets, auxiliary equipment and cables.

- NEXO cannot accept responsibility for accidents caused by any factor other than defects in this product itself.
- Please check the web site nexo-sa.com for the latest update.