



P series

Compact, high-output, point source loudspeakers and sub-bass cabinets



Live Events



Corporate & Public Spaces



Theatres



Clubs



Bars & Restaurants



Houses of Worship



Sports Arenas



Immersive Audio

A point source powerhouse

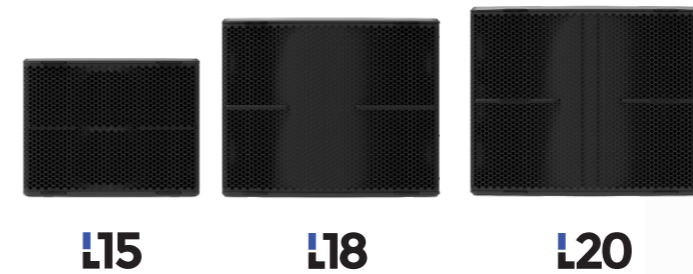
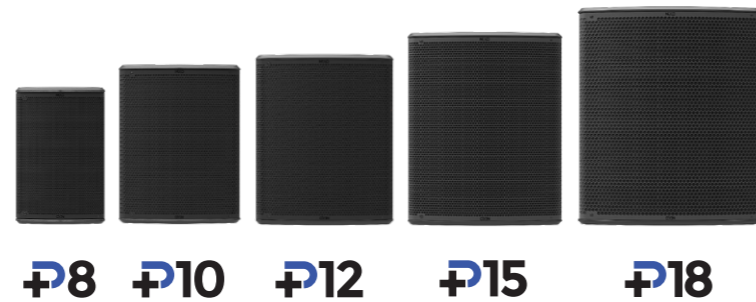

Building on NEXO's acclaimed expertise in compact, high-output, point source loudspeakers, the P+ Series delivers pristine, full-range sound at even greater Sound Pressure Levels, along with unparalleled versatility, thanks to an ingenious system for varying HF coverage patterns.

An exciting synergy of sleek good looks and stunning performance, the P8, P10, P12, P15 and P18 loudspeakers employ custom 8, 10, 12, 15 and 18-inch LF/HF drivers in a coaxial configuration to deliver perfect phase alignment, exceptional clarity and a smooth response across the full frequency range. Available in mobile and install versions, the curved, low-profile cabinets can be deployed both vertically or horizontally (as a wedge monitor), in Touring, Install and TIS versions and feature pole-mounting hardware and rigging points. Additionally, the P12, P15 and P18 can be used in both Active and Passive modes.

The L15, L18 and L20 subs are ideal partners for the P+ Series main cabinets, extending LF performance down to 40Hz, 32Hz and 28Hz respectively, while NEXO's NXAMPmk2 or DTD/ DTDAMP deliver tailored power and processing solutions, combining multi-channel, high powered, networkable amplification with sophisticated loudspeaker control and protection. Linear phase presets for P+ cabinets in both vertical and horizontal configuration – and for the full range of NEXO cabinets – make it quick and easy to configure a 'Plug & Play' solution for any system.

With the P+ Series, musicians, DJs, theatres and event organisers can expect extraordinary performance from a compact system, while production and rental companies look set to enjoy the industry-leading levels of return on investment upon which the reputation of NEXO point source loudspeakers are built.



P8, P10, P12, P15, P18 Main Cabinets



Dedicated L15, L18 and L20 Subs



142dB Peak SPL (P18/Active Mode)



Variable HF Directivity



Low-Profile Cabinets



Coaxial, Long-Excursion Drivers



Active/Passive Switching (P12/P15/P18)



Touring, Install and TIS Versions

Variable HF Directivity

Optimise the dispersion for your application in just a few moments

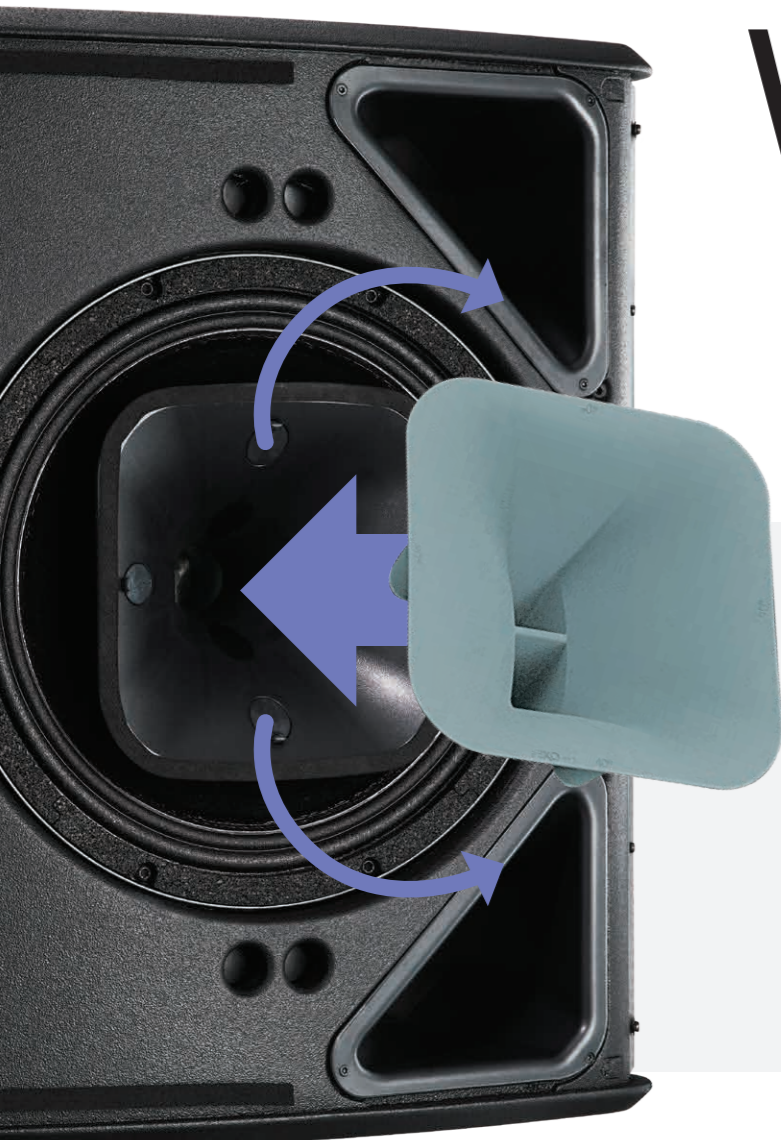

P12, P15 and P18 optional magnetic flanges

The dispersion characteristics of the P12, P15 and P18 can be changed in seconds through the addition of optional magnetic flanges. The standard cabinets use a 60° x 60° horn with additional 90° x 40° and Asymmetrical (PS Type) 60° - 100° x 40° also available.

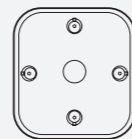

Standard Horn Profile
60° x 60° Dispersion

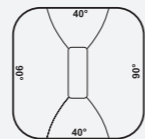

90° x 40° Horn Flange
Rotatable

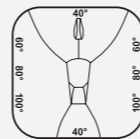

Asymmetrical (PS Type)
PNT-P12FLGPS - (60°-100°) x 40°
PNT-P15FLGPS - (50°-90°) x 40°
PNT-P18FLGPS - (50°-90°) x 40°

Presets for vertical and horizontal deployment

A dedicated NXAMP preset for every horn/flange configuration in each P+ Series cabinet ensures perfect coverage at any frequency. The phase of the P+ Series setups is compatible with all other NEXO speakers and subs, except for the monitor setups where latency is minimised.

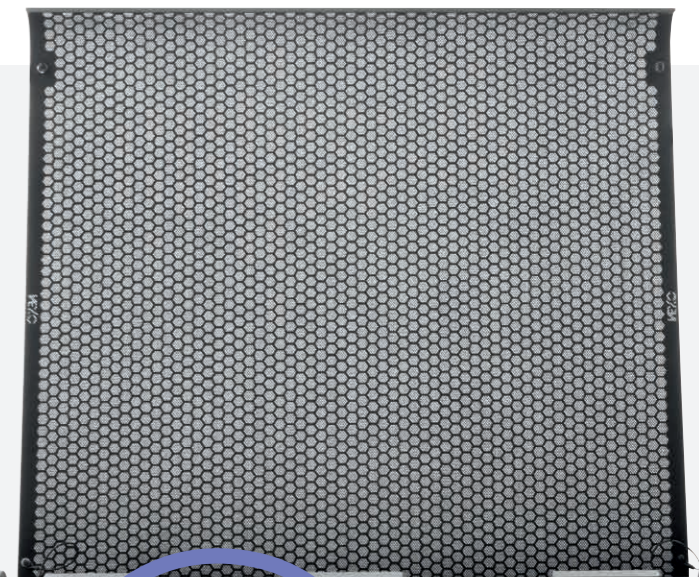

P8 and P10 optional magnetic horn

By default, the P8 and P10 cabinets use a 100° x 100° horn. In the case of these cabinets, the dispersion characteristics can be changed by fitting an optional, rotatable 110° x 60° horn.

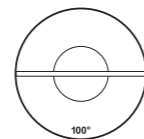

Standard Horn
100° x 100° Dispersion

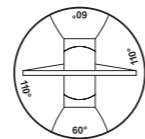

110° x 60° Horn
Rotatable

Advanced cabinet design with quick-release grille

Changing the horn/flanges is easy and requires no tools – the quick-release steel grille can be removed in seconds providing full access (touring versions only).

With a fully symmetric design, there are no left or right versions of the P+ Series cabinets, so inventory requirements are significantly streamlined. The cabinets are built around a 15mm (18mm for P18) custom-profiled plywood shell, using poplar veneer for the inner layers and birch on the outside to ensure strength, rigidity and light weight. Bass-reflex tuning is achieved through two computer-optimised ports to deliver ultra-low distortion, even at very high output levels.



Configure the perfect system

Main Cabinets



P8

Measuring 276mm wide x 423mm high x 250mm deep and weighing 12Kg, the P8 can be deployed in vertical or horizontal (wedge monitor) configurations, with HF directivity set to match the specific application. P8 cabinets are available in touring, installation and hybrid TIS formats.



129dB Peak SPL



8-inch Bass/ Mid Driver



P10

Measuring 384mm wide x 497mm high x 274mm deep and weighing 15Kg, the P10 can be deployed in vertical or horizontal (wedge monitor) configurations, with HF directivity set to match the specific application. P10 cabinets are available in touring, installation and hybrid TIS formats.



136dB Peak SPL



10-inch Bass/ Mid Driver



P12

Measuring 432mm wide x 531mm high x 317mm deep and weighing 20Kg, the P12 can be deployed in vertical or horizontal (wedge monitor) configurations, with HF directivity set to match the specific application. P12 cabinets are available in touring, installation and hybrid TIS formats.



138dB (passive) / 140dB (active) Peak SPL



12-inch Bass/ Mid Driver



Passive/Active Modes

Sub-bass Cabinets

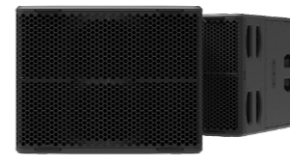

L15

Measuring 650mm wide x 430mm high x 550mm deep and weighing 35Kg, the L15 sub employs a 15" long excursion driver in Baltic birch / poplar plywood cabinet with threaded inserts for mounting accessories and an M20 stand fitting. Available in touring format only.



139dB Peak SPL



15-inch Bass Driver

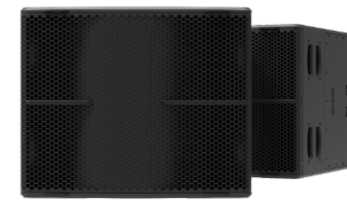

L18

Measuring 680mm wide x 559mm high x 775mm deep and weighing 50Kg, the L18 sub employs a 18" long excursion driver in Baltic birch / poplar plywood cabinet with threaded inserts for mounting accessories and an M20 stand fitting. Available in touring format only.



140dB



18-inch Bass Driver

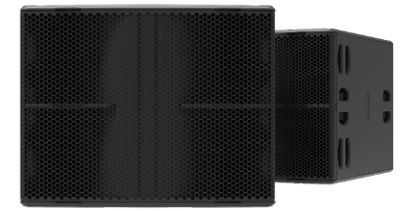

L20

Measuring 755mm wide x 594mm high w 905mm depth and weighing 59 Kg, the L20 sub employs a 20" long excursion driver in Baltic birch / Poplar plywood cabinet with threaded inserts for mounting accessories and M20 stand fitting. Available in touring format only.



141dB



20-inch Bass Driver



P15

Measuring 483mm wide x 600mm high x 352mm deep and weighing 23Kg, the P15 can be deployed in vertical or horizontal (wedge monitor) configurations, with HF directivity set to match the specific application. P15 cabinets are available in touring, installation and hybrid TIS formats.



141dB (active) / 139dB (passive) Peak SPL



15-inch Bass/ Mid Driver



Passive/Active Modes



P18

Measuring 579mm wide x 680mm high w 446mm depth and weighing 33Kg, the P18 can be deployed in vertical or horizontal (wedge monitor) configurations, with HF directivity set to match the specific application. P18 cabinets are available in touring, installation and hybrid TIS formats.



142dB (active) / 140dB (passive) Peak SPL



18-inch Bass/ Mid Driver



Passive/Active Modes

Touring and Installation Versions

P+ Series main cabinets are available in touring, installation or hybrid 'TIS' formats. The touring models feature rugged, quick-release steel grilles and handles with integrated 35mm pole mounts on both sides / ends of the cabinet. Speakon connectivity is replicated on the cabinet sides and rear panel, ensuring tidy wiring when used in either main or wedge monitor configurations. Installation versions feature a fixed cloth-

covered grille, universal rigging points on the sides and bottom of the cabinet and 2-core cable for audio input to ensure IP54 protection index. TIS versions feature touring handles and connectivity, with cloth-covered grilles. The L15, L18 and L20 subs are available in touring format only.

P Series (not only install) can be specified in any RAL colour



Touring Cabinet Connectivity



Installation Cabinet Connectivity



DJ



Music



Events



Theatre



Public Spaces



Bringing precision, high-output performance to a range of fixed and mobile applications

The facility to change the HF directivity makes the P+ Series extremely flexible in a range of mobile and fixed applications. Deployed as a wedge monitor, the P+ cabinets become uniquely versatile, as sound engineers and rental companies can quickly 'tune' the HF coverage to suit the musician: wide for guitarists or narrow for brass sections, while a P+ main cabinet on an L sub creates a perfect drum fill monitor.

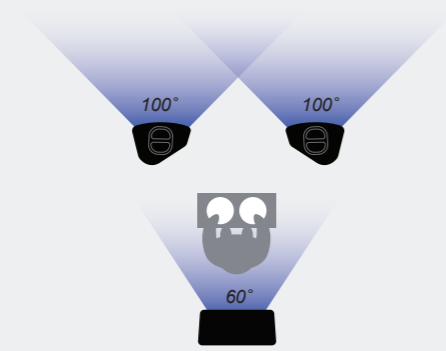

Small Club: 2 x P12 with 'PS Horn' for FOH, 1 x P12 with standard horn for monitor

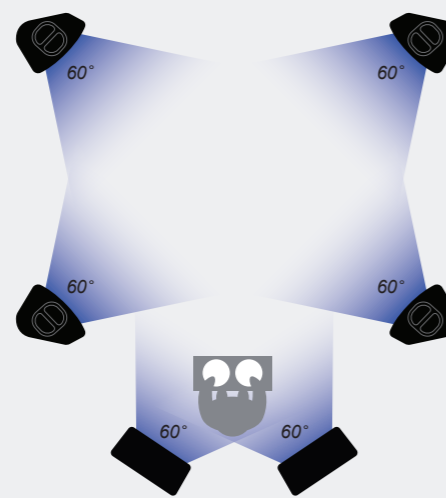

Large Club: 4 x P18 located in each corner of the room, with 2 x P12 as monitors – all standard horns

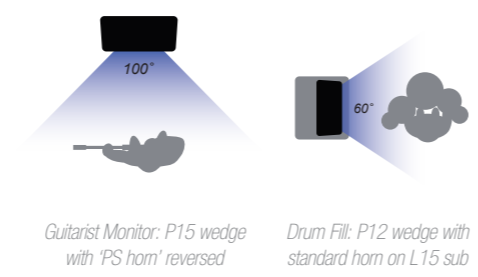

Guitarist Monitor: P15 wedge with 'PS horn' reversed

Drum Fill: P12 wedge with standard horn on L15 sub

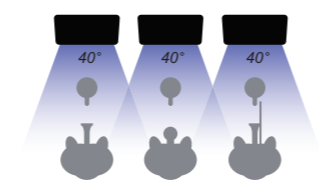

Brass Section Monitors: P12 wedges with 90° x 40° horn for narrow horizontal coverage

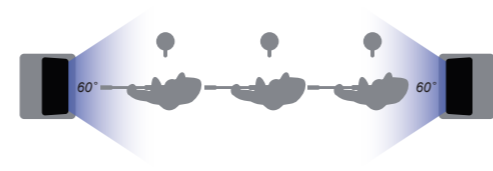

Side Fills: P12 wedges (standard horn) on L15 subs on each side

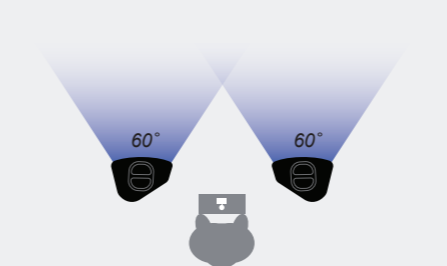

Simple System: 2 x P12 with standard horn

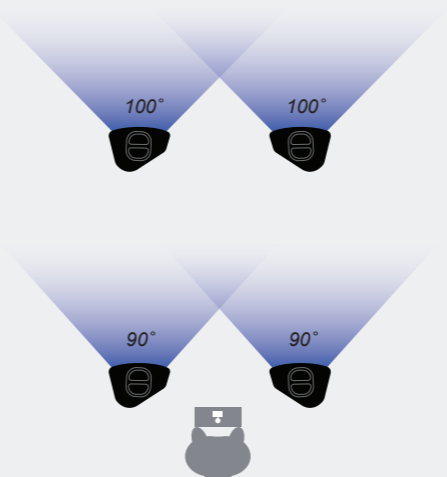

Long Throw System: 2 x P18 + 2 x P12 delayed – all with 'PS horn'



Small Theatre: 2 x P10 with standard horn as FOH

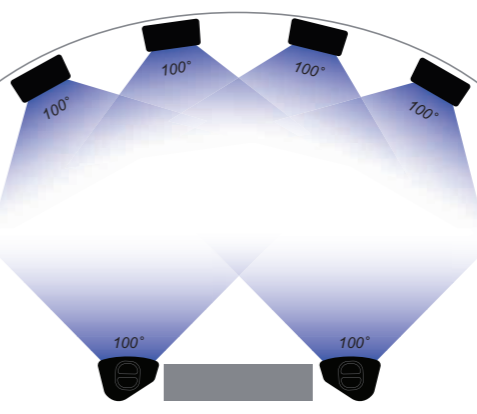

Large Theatre: 2 x P15 with 'PS horn' for FOH + 4 x P8 with standard horn under balcony

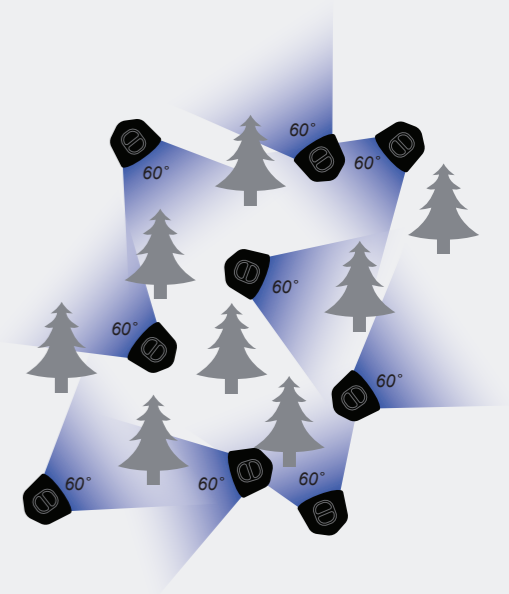

Leisure Park: 9 x P8 with 110° x 60° as a distributed system

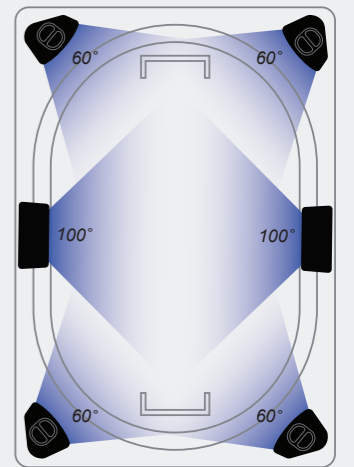

Small stadium: 4 x P12 with standard horn + 2 x P12 with 'PS horn' reversed

P8 Recommended Systems

It's easy to configure touring and fixed installation P8/L15 systems using DTD/DTDAMP and NXAMP4X1MK2 power and processing

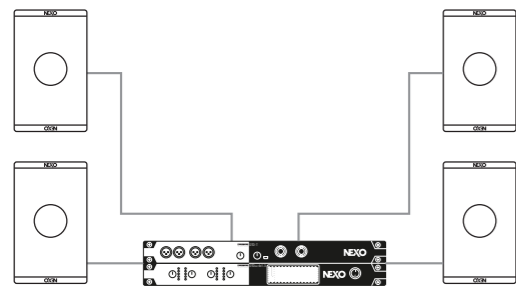

Stereo System: 2 x P8 per side powered by 1 x DTD/1 x DTDAMP4x0.7

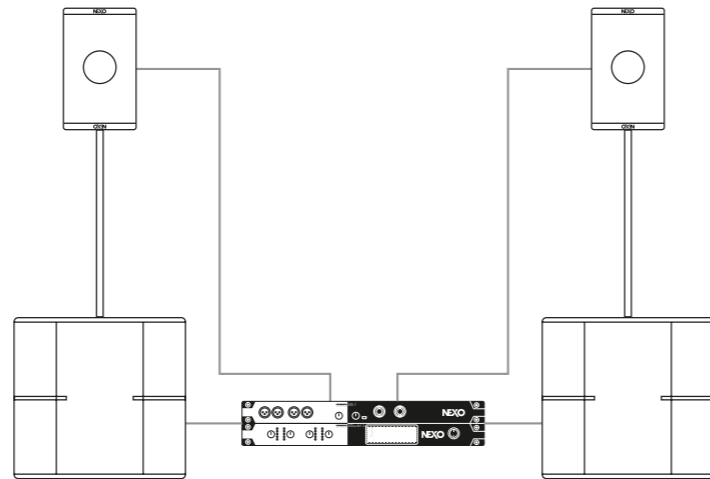

Stereo System with Subs: 1 x P8 + 1 x L15 per side powered by 1 x DTD/1 x DTDAMP4x1.3

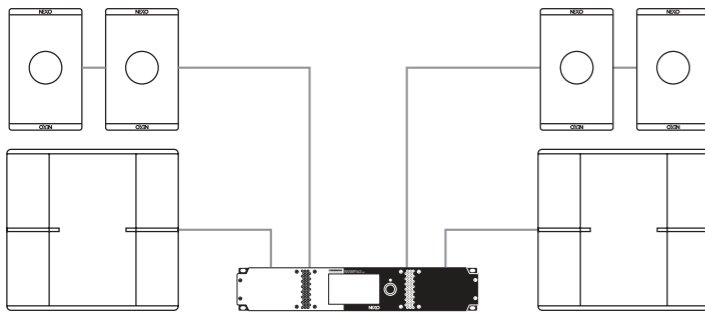

Higher Power System with Sub: 4 x P8 + 2 x L15 powered by NXAMP4X1MK2

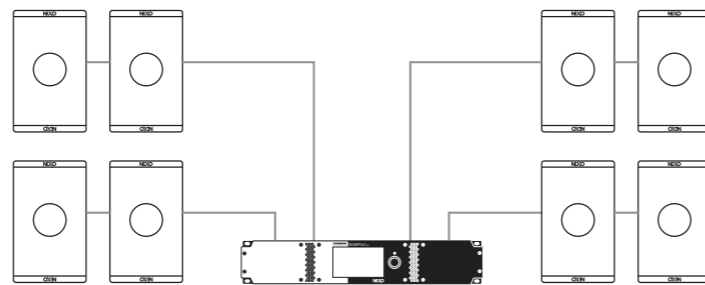

Distributed System: 8 x P8 powered by NXAMP4X1MK2

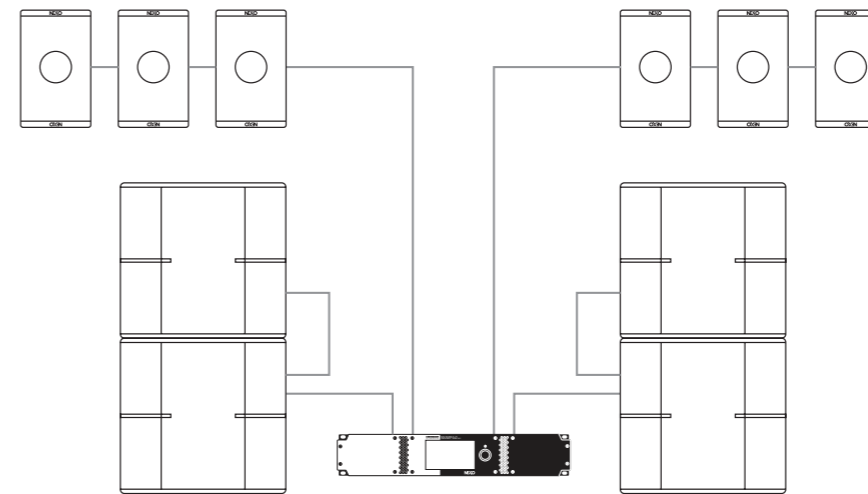

Compact, High-Power System: 6 x P8 + 4 x L15 powered by NXAMP4X2MK2



DTD-T/DTDAMP

DTD/DTDAMP: Dedicated power and processing for touring and installed systems

Ideal for powering smaller P+ Series systems, the 4-channel, 1U rack-mounting DTDAMP is available in two versions: 4 x 700 Watts and 4 x 1300 Watts (4 x 4 Ohms). The DTDAMP partners perfectly with the touring and install versions of the DTD Controller to create a compact, light-weight, intelligent powering solution that's easy to configure – either in a 'dry hire' application where the user has limited knowledge, or in a fixed installation.

And for more power, the NXAMP4X1MK2 combines advanced signal processing with 4 x 1300 Watts amplification.

P10 Recommended Systems

DTD/DTDAMP and NXAMP_{MK2} provide flexible power and processing solutions for P10/L15 systems

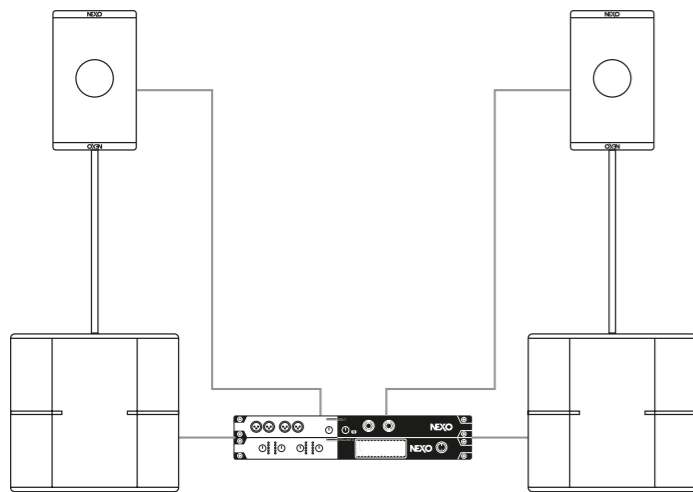

Stereo System: 2 x P10 + 2 x L15
powered by 1 x DTD/1 x DTDAMP4x1.3

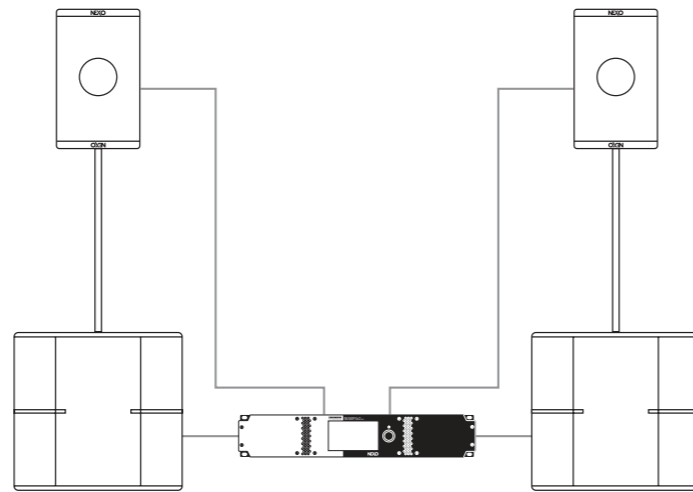

Stereo System: 2 x P10 + 2 x L15
powered by NXAMP4X1_{MK2}

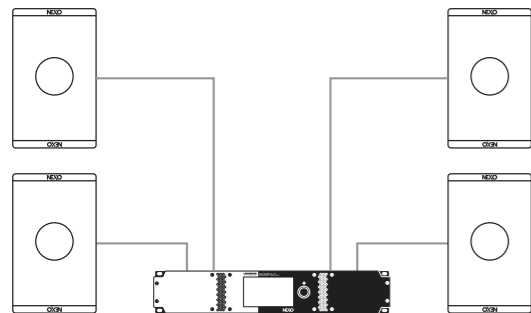

Distributed System: 4 x P10
powered by NXAMP4X1_{MK2}

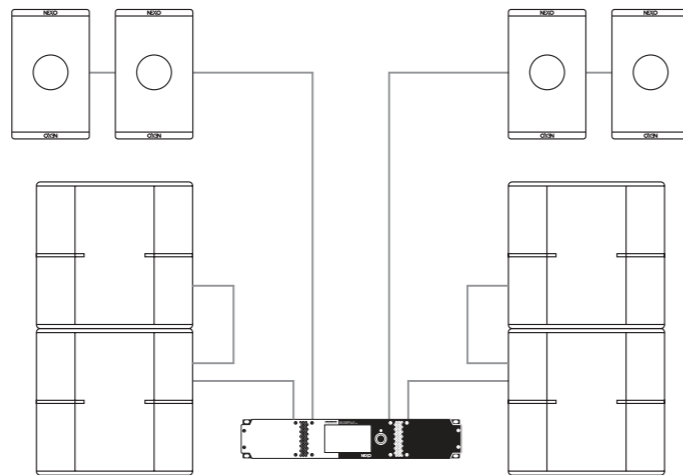

Compact, High-Powered System: 4 x P10 + 4 x L15
powered by NXAMP4X2_{MK2}

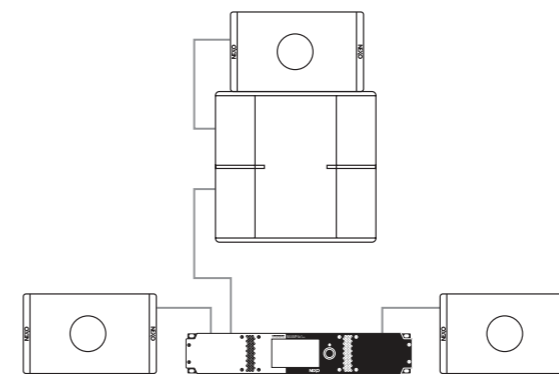

Monitor System: 1 x P10 Wedge on 1 x L15 Sub (Drum Fill)
+ 2 x P10 Wedges powered by NXAMP4X1_{MK2}



NXAMP4X2MK2: The perfect power and processing partner

With models rated at 4 x 1300 Watts, 4 x 2500 Watts and 4 x 4500 watts, NXAMP_{MK2} combines advanced signal processing with four state-of-the-art Class D amplifiers to create a flexible, light-weight powering and control solution that's perfect for use with P+ Series systems. Easy to set up and quick to deploy, all essential parameters are readily accessible via a large colour touch-screen on the front panel, with a comprehensive range of control and networking facilities on the rear panel. 32-bit/96KHz converters and 64-bit signal processing combine to assure pristine sound quality.



*optional

P12 Recommended Systems

NXAMP4X2MK2 delivers the perfect power and processing solution for P12/L15 systems in a variety of configurations

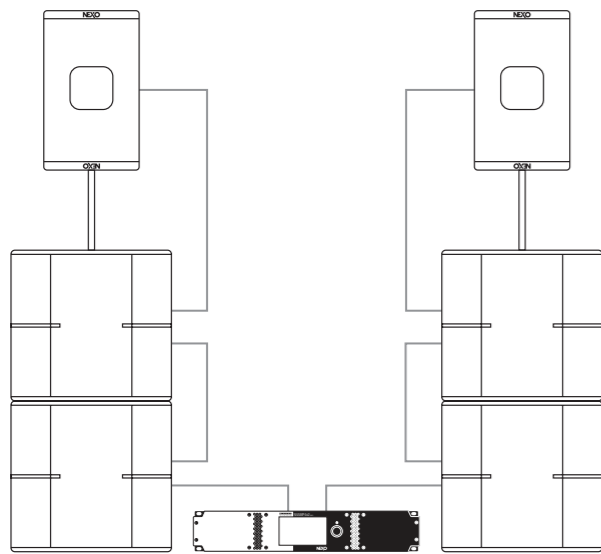

Stereo System: 1 x P12 (Passive) with pole stand on 2 x L15 Sub per side

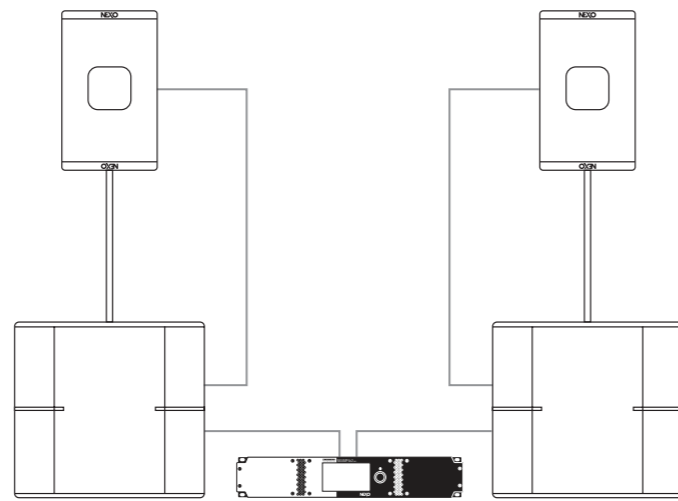

Stereo System: 1 x P12 (Passive) with pole stand on 1 x L18 Sub per side

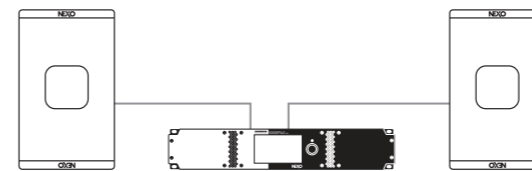

Active System: Stereo, 1 x P12 (Active) per side

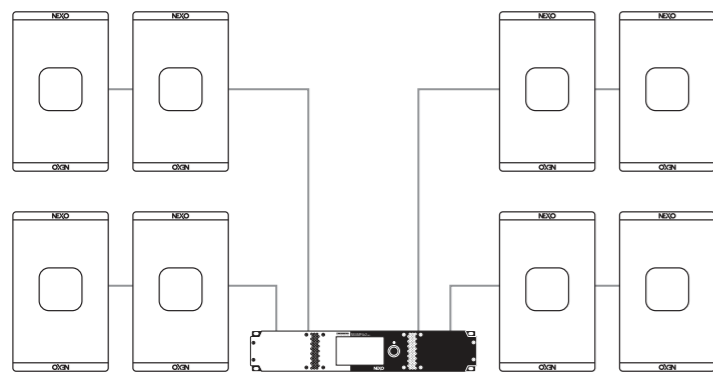

Distributed System: 8 x P12 (Passive) – 2 per amplifier channel

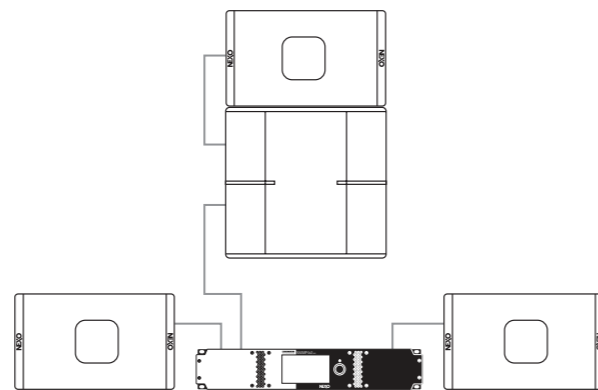

Monitor System: 1 x P12 Wedge on 1 x L15 Sub (Drum Fill) + 2 x P12 Wedges

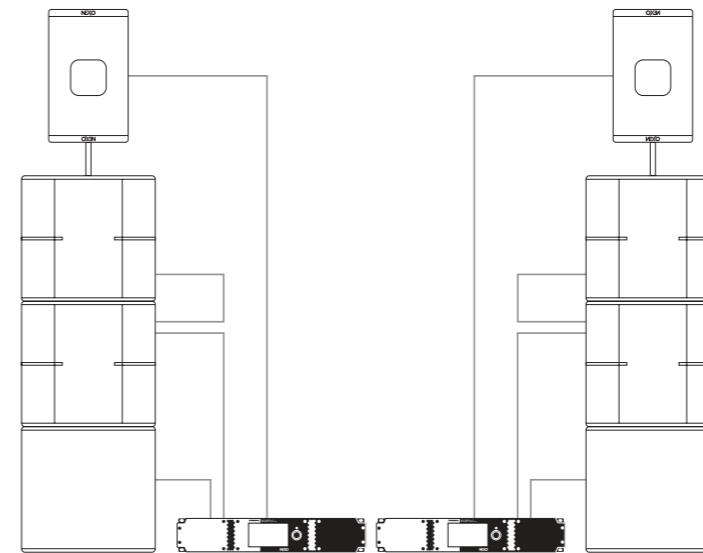

Mid-Sized FOH System: (Per side) 1 x P12 (Active) on 2 x L15 Subs on 1 x L15 Sub (Cardioid Mode)

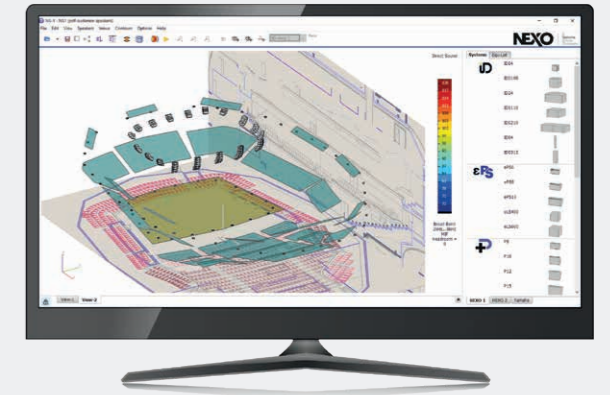

System configuration, management and remote control software

NEXO software applications make it easy to design, configure and implement P+ Series systems in mobile and fixed installations.

NS-1

Available to download free of charge, NS-1 is a powerful and intuitive system configuration and simulation tool enabling NEXO users to configure and optimise the performance of any NEXO system by predicting its behaviour in any venue to ensure uniform SPL coverage.

P15 Recommended Systems

NXAMP4X2MK2 delivers the perfect power and processing solution for P15/L18 systems in a variety of configurations

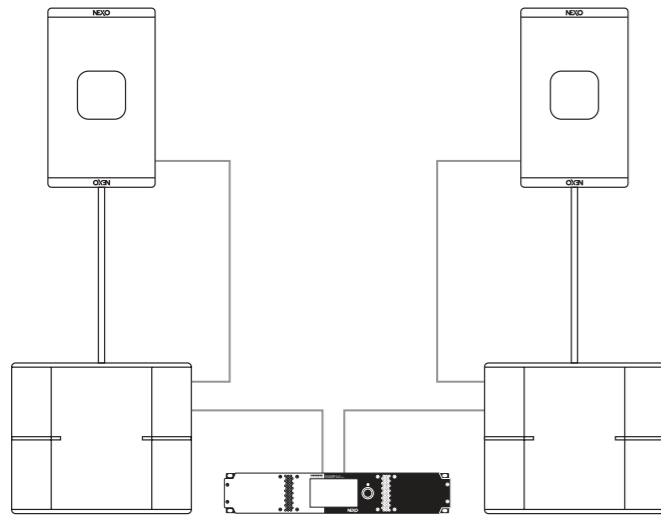

Stereo System: 1 x P15 (Passive) with pole stand on 1 x L18 Sub per side, powered by 1 x NXAMP4X2MK2

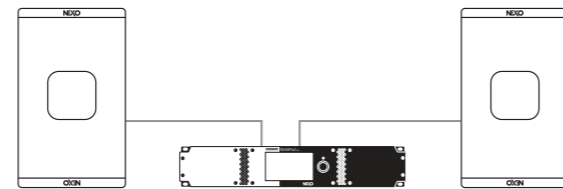

Active System: Stereo, 1 x P15 (Active) per side, powered by 1 x NXAMP4X2MK2

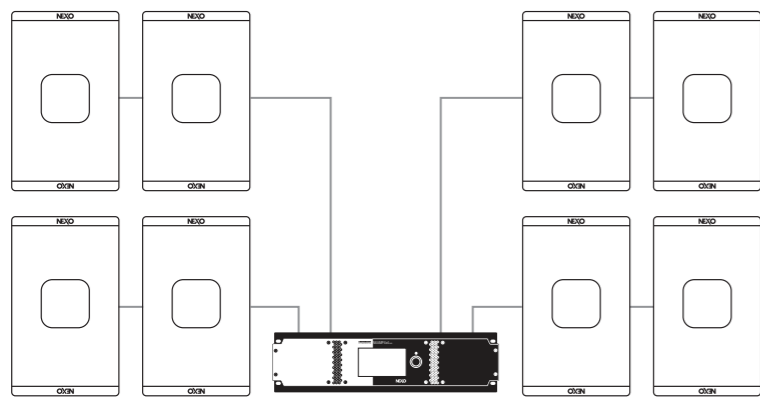

Distributed System: 8 x P15 (Passive), powered by 1 x NXAMP4X4MK2

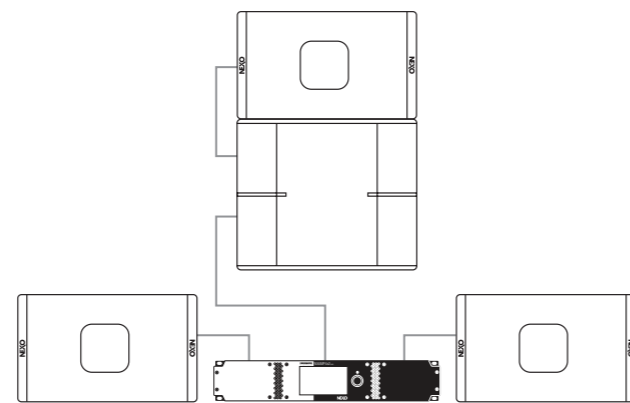

Monitor System: P15 wedge on 1 x L18 (Drum Fill) + 2 x P15 wedges, powered by 1 x NXAMP4X2MK2

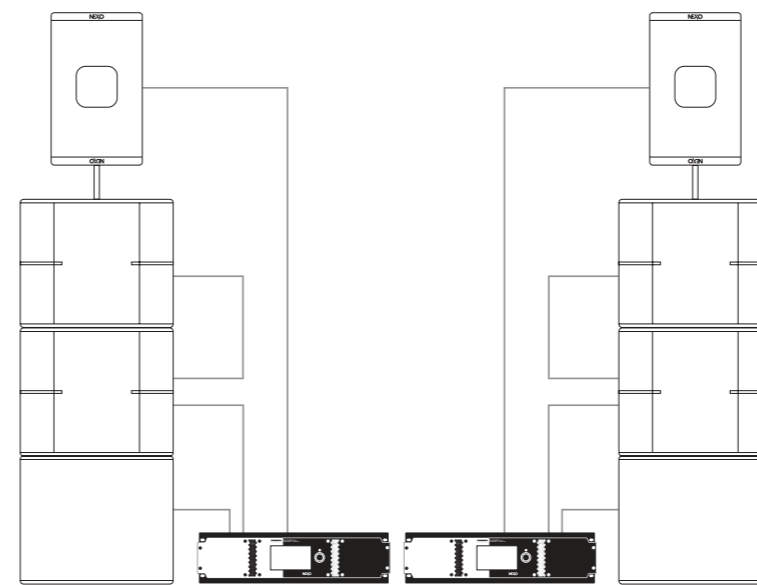

Mid-Sized FOH System: (Per side) 1 x P15 (Active) on 2 x L18 Subs on 1 x L18 Sub (Cardioid Mode), powered by 2 x NXAMP4X4MK2



System configuration, management and remote control software

NEXO software applications make it easy to design, configure and implement P+ Series systems in mobile and fixed installations.

NeMo

NeMo System Management software delivers remote control of a NEXO DTD/DTDAMP or NXAMP_{MK2}-powered system from a Windows, macOS or iOS device. Managing and positioning devices, monitoring their parameters (levels, etc.), and setting new values (preset, volume, delay, EQ, etc.) are all made possible via an attractive and intuitive user interface. NeMo also includes a powerful engine for logging and alerting.

ProVisionaire

NXAMP_{MK2} - powered P+ systems can also be controlled directly from Yamaha digital mixing consoles and are included in Yamaha's ProVisionaire control and monitoring software for installed systems.

P18 Recommended Systems

NXAMP4X4MK2 delivers the perfect power and processing solution for P18/L20 systems in a variety of configurations

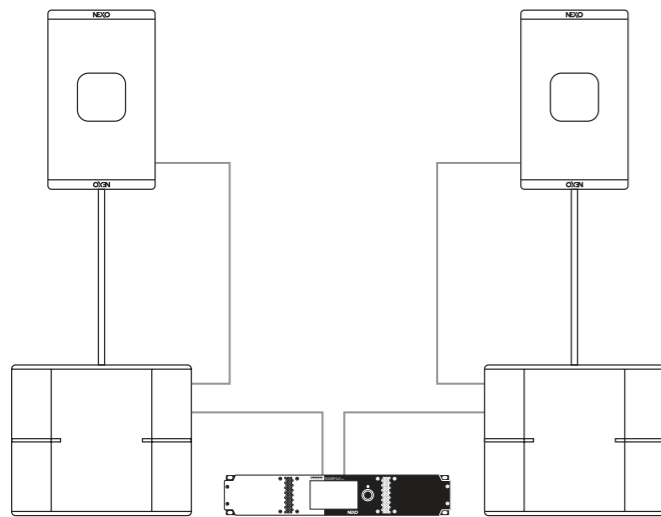

Stereo System: 1 x P18 (Passive) with pole stand on 1 x L20 Sub per side, powered by 1 x NXAMP4X4MK2

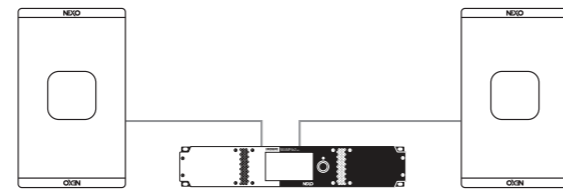

Active System: Stereo, Stereo, 1 x P18 (Active) per side, powered by 1 x NXAMP4X4MK2

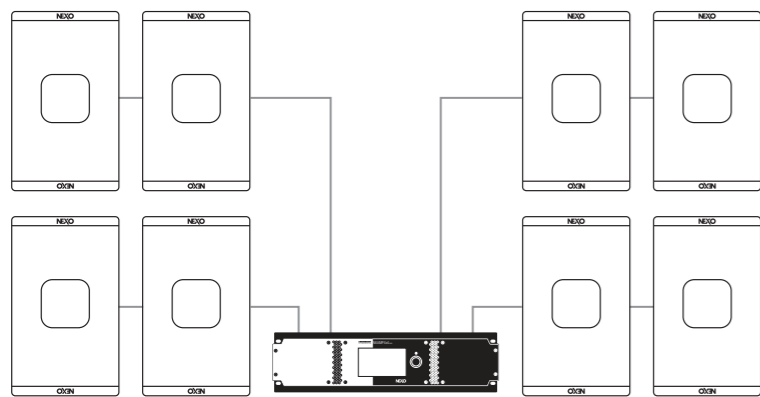

Distributed System: 8 x P18 (Passive) powered by 1 x NXAMP4X4MK2

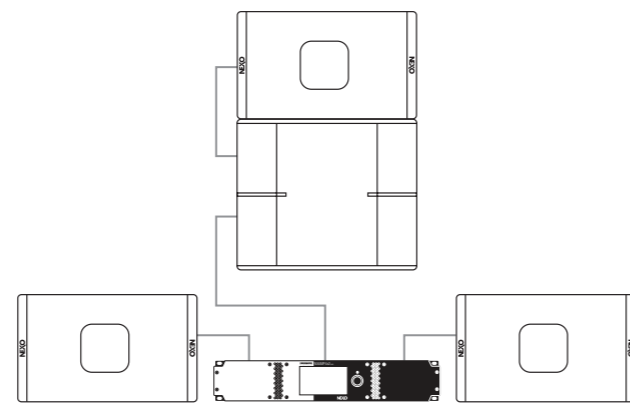

Monitor System: P18 wedge on 1 x L20 (Drum Fill) + 2 x P18 wedges, powered by 1 x NXAMP4X4MK2



FOH System: (Per side) 1 x P18 (Passive) on 2 x L20 Subs on 1 x L20 Sub (Cardioid Mode), powered by 2 x NXAMP4X4MK2



P12 / P15 / P18 active and passive modes

Touring and TIS versions of the P12, P15 and P18 cabinets incorporate an Active/Passive switch. In Passive mode, a passive circuit filters a single channel of amplification appropriately for the high and low frequency drivers. In active mode, an active crossover filters two independent amplification channels, resulting in even higher SPL performance of 140dB, 141dB and 142dB respectively for the P12, P15 and P18, along with reduced distortion and enhanced dispersion around the crossover frequencies.

P+ Series Mounting Accessories

Horizontal Mount

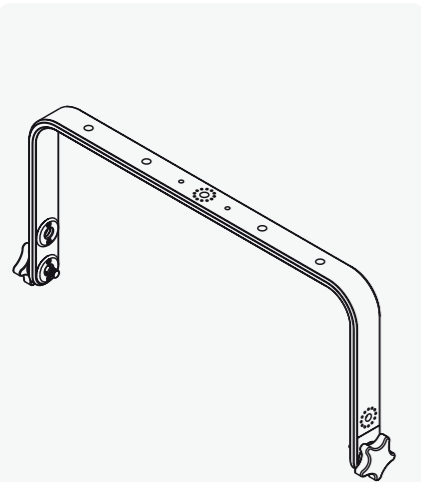

For P8: VNU-HBRK425
For P10: VNU-HBRK500
For P12: VNU-HBRK535
For P15: VNU-HBRK600
For P18: VNU-HBRK680

Can be used with:

Truss Clamp



Wall Mount*

For P8: VNI-WM200
For P10: VNI-WM280
For P12: VNI-WM330
For P15: VNI-WM380
For P18: VNI-WM450

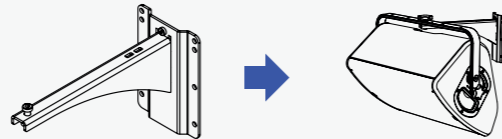

Ceiling Mount

For P8, P10, P12, P15, P18:
VNI-CLADAPT



Pole Stand

For P8, P10, P12, P15, P18:
VNU-PLADAPT



Vertical Mount

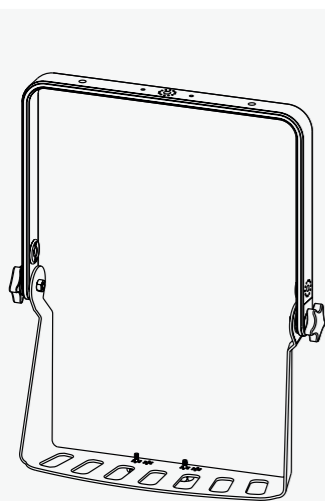

For P8: PNU-VBRK8
For P10: PNU-VBRK10
For P12: PNU-VBRK12
For P15: PNU-VBRK15
For P18: PNU-VBRK18

Can be used with:

Truss Clamp



Wall Mount*

For P8: VNI-WM200
For P10: VNI-WM280
For P12: VNI-WM330
For P15: VNI-WM380
For P18: VNI-WM450



Ceiling Mount

For P8, P10, P12, P15, P18:
VNI-CLADAPT



Pole Stand

For P8, P10, P12, P15, P18:
VNU-PLADAPT



Bumper Mount

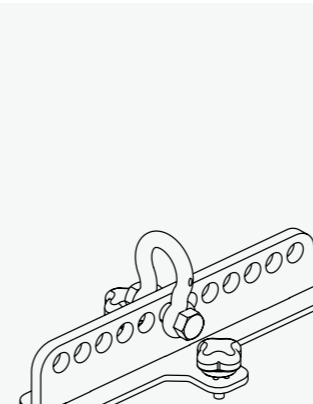

For P8, P10, P12, P15, P18:
VNU-BUMP

Can be used with:

Adapter + Truss Clamp

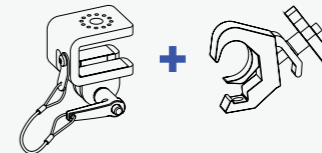

For P8, P10, P12, P15, P18:
VNI-WMADAPT

Adapter + Wall Mount

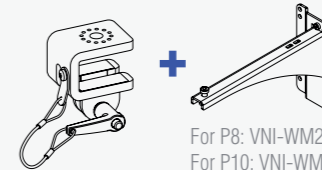

For P8, P10, P12, P15, P18:
VNI-WMADAPT

For P8: VNI-WM200
For P10: VNI-WM280
For P12: VNI-WM330
For P15: VNI-WM380
For P18: VNI-WM450

L15, L18 and L20 Mounting Accessories

Horizontal Mount

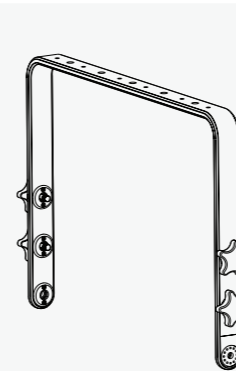

For L15: LNT-HBRK15
For L18: LNT-HBRK18
For L20: LNT-HBRK20

Can be used with:

Truss Clamp

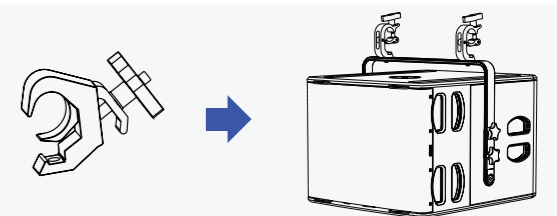

Ceiling Mount

For L15, L18, L20:
VNI-CLADAPT

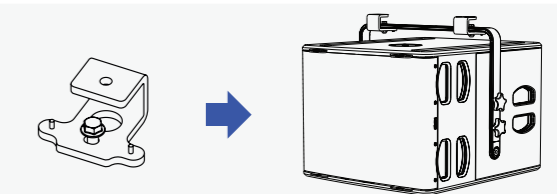

* VNI-WM wall mountings are cross-compatible across all P+ cabinets. See dedicated documentation for maximum angle for specific VNI-WM / P+ cabinet pairings.



A powerful, full range cluster that saves available floor space

P12/L15, P15/L18, P18/L18 and P18/L20 clusters

The PNI-P12TOL15 creates a high power density full range point source system for mid-throw applications. It can combine a P12 under a L15 (with selectable angle between the two cabinets) or 2x L15 (eventually one being reversed for Cardioid applications). Eye bolts or truss clamp can be used on the top plate to hang the system, or the top plate can directly be screwed into a ceiling.

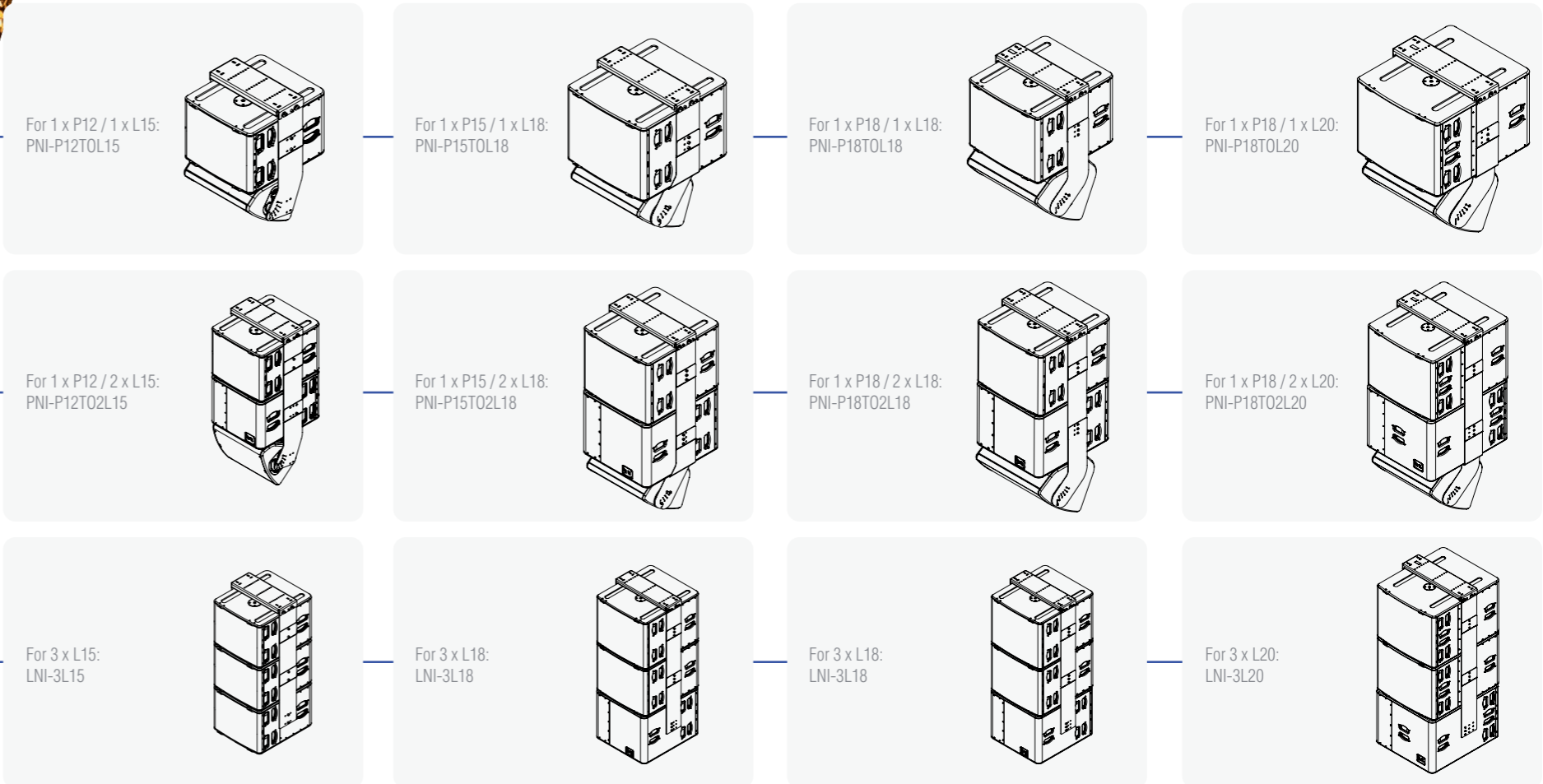
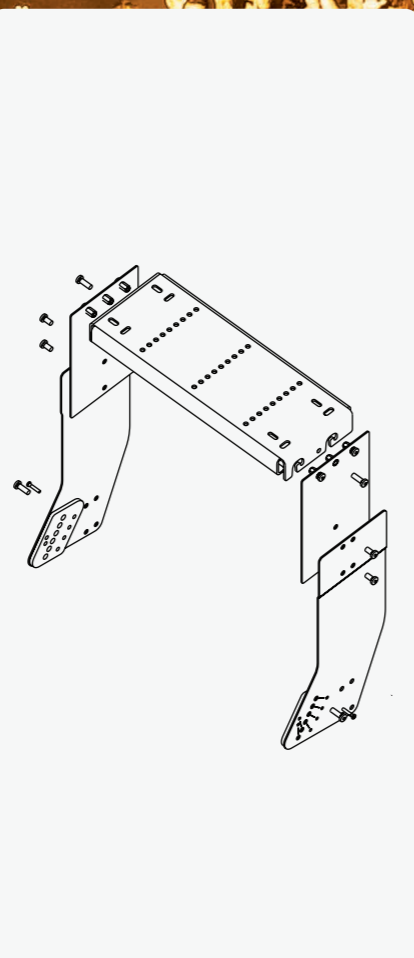

Optional Magnetic Horns and Flanges

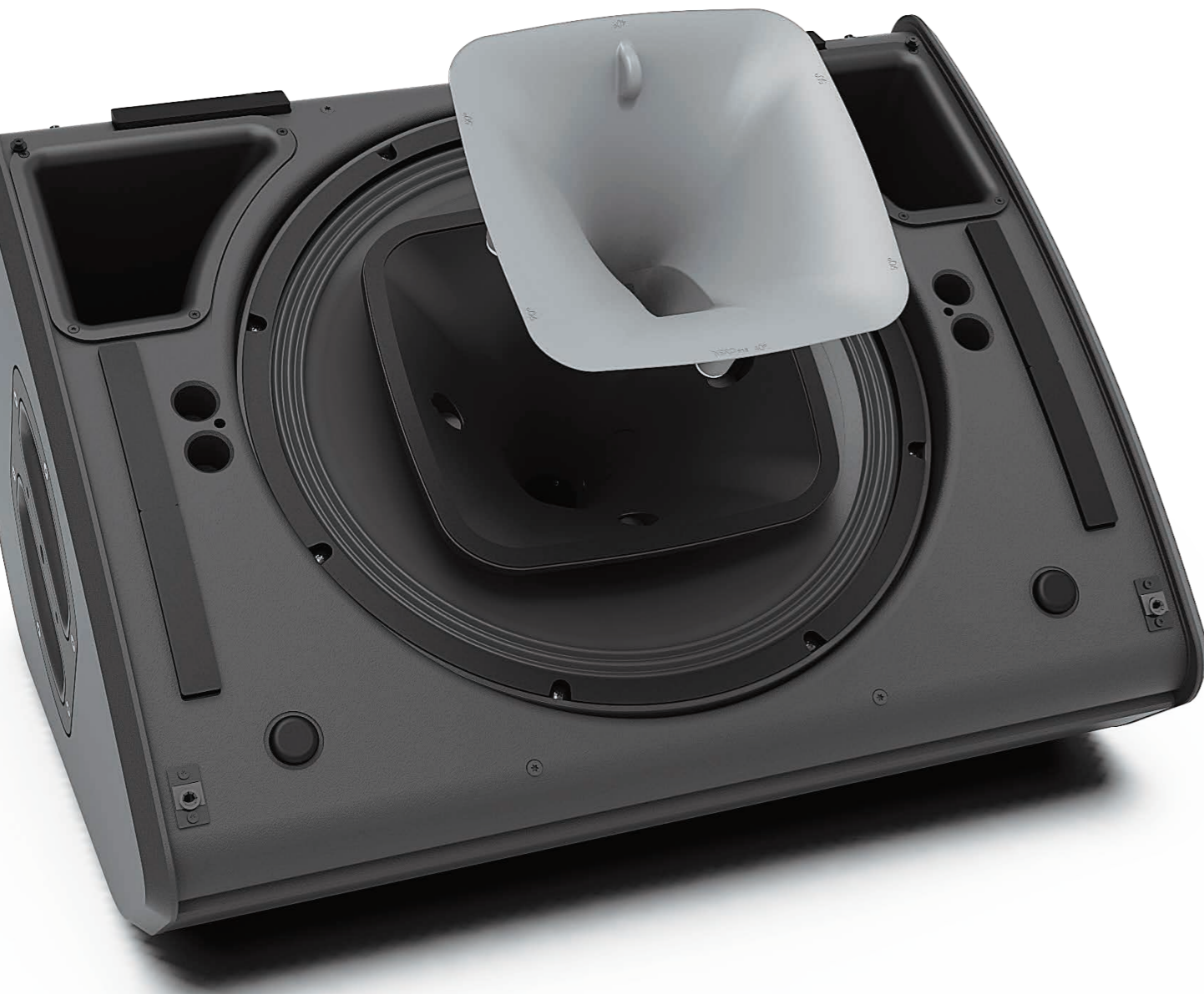

P8 Optional Magnetic Horns

By default, the P8 also uses a 100° x 100° horn. The dispersion characteristics can be changed by fitting an optional, rotatable 110° x 60° horn.

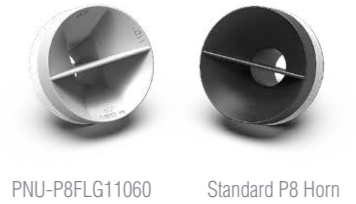

PNU-P8FLG11060 Standard P8 Horn



Standard P10 Horn PNU-P10FLG11060

P10 Optional Magnetic Horns

By default, the P10 uses a 100° x 100° horn. The dispersion characteristics can be changed by fitting an optional, rotatable 110° x 60° horn.

P12 Optional Magnetic Flanges

The dispersion characteristics of the P12 can be changed in seconds through the addition of optional magnetic flanges. The standard cabinet uses a 60° x 60° horn with additional 90° x 40° and Asymmetrical (PS Type) 60° - 100° x 40° also available.



PNU-P12FLG9040 Standard P12 Horn PNU-P12FLG9040 PNU-P12FLG9040



PNU-P15FLG9040 Standard P15 Horn PNU-P15FLG9040

P15 Optional Magnetic Flanges

The dispersion characteristics of the P15 can be changed in seconds through the addition of optional magnetic flanges. The standard cabinet uses a 60° x 60° horn with additional 90° x 40° and Asymmetrical (PS Type) 50° - 90° x 40° also available.

P18 Optional Magnetic Flanges

The dispersion characteristics of the P18 can be changed in seconds through the addition of optional magnetic flanges. The standard cabinet uses a 60° x 60° horn with additional 90° x 40° and Asymmetrical (PS Type) 50° - 90° x 40° also available.



PNU-P18FLG9040 Standard P18 Horn PNU-P18FLG9040

Flight Cases and Covers

The P+ Series includes a comprehensive range of flight cases and covers, including cases for accessories.



- PNT-4CASE8** Flight case for 4 x P8
- PNT-2CASE10** Flight case for 2 x P10
- PNT-2CASE12** Flight case for 2 x P12
- PNT-2CASE15** Flight case for 2 x P15
- PNT-2CASE18** Flight case for 2 x P18

- PNT-ACC8** Flight case for 4 x set of P8 accessories, one set includes : 1 optional horn, Bumper, Pole stand adapter, vertical bracket, horizontal bracket.
- PNT-ACC10** Flight case for 2 x set of P10 accessories, one set includes : 1 optional horn, Bumper, Pole stand adapter, vertical bracket, horizontal bracket.
- PNT-ACC12** Flight case for 2 x set of P12 accessories, one set includes : 2 types of Flanges, Bumper, Pole stand adapter, vertical bracket, horizontal bracket.
- PNT-ACC15** Flight case for 2 x set of P15 accessories, one set includes : 2 types of Flanges, Bumper, Pole stand adapter, vertical bracket, horizontal bracket.
- PNT-ACC18** Flight case for 2 x set of P18 accessories, one set includes : 2 types of Flanges, Bumper, Pole stand adapter, vertical bracket, horizontal bracket.

- PNT-COV8** Cover for P8
- PNT-COV10** Cover for P10
- PNT-COV12** Cover for P12
- PNT-COV15** Cover for P15
- PNT-COV18** Cover for P18

- LNT-2CASE15** Flight case for 2 x L15
- LNT-COV15** Cover for L15
- LNT-COV18** Cover for L18
- LNT-COV20** Cover for L20
- LNT-WB15** Wheel board for L15
- LNT-WB18** Wheel board for L18
- LNT-WB20** Wheel board for L20

Specifications



P8 cab in main (vertical) and wedge (horizontal) configurations



P10 cab in main (vertical) and wedge (horizontal) configurations



P12 cab in main (vertical) and wedge (horizontal) configurations



P15 cab in main (vertical) and wedge (horizontal) configurations



P18 cab in main (vertical) and wedge (horizontal) configurations

P8

P8 with NEXO processing	
Frequency Response (-6 dB)	66 Hz to 20 kHz
Sensitivity 1W@1m	101 dB SPL Nominal
Peak SPL Level (1m)	129 dB Peak
Recommended Power	350 to 550 Watts / 8 Ohms
HF Dispersion (according to horn)	100°x100° (Default) - 110°x60° (with 110°x60° optional horn)
Crossover Frequency	66 Hz, 85 Hz, 120 Hz
Nominal Impedance	8Ω

Product Features	
Components	1 x Coaxial LF 8" 8 Ohms long excursion & Neodymium HF 1.5" 8 Ohms
Number of ways	2 ways passive
Connectors (Touring and TIS versions)	4 x NL4, 4 poles connectors (1 per handle + 2 at the back)
Connectors (Install version)	1 x Cable gland with 2 cores cable
Rigging points	1 x universal accessory fit on each side + 1 x on the bottom
Material	Custom made bent plywood of Baltic birch and poplar
Finish	Black or White structural paint
Front Finish (Touring version)	Magnelis® steel front grille + back mesh
Front Finish (Install and TIS versions)	UV resistant acoustic fabric fitted front grill
Height x Width x Depth	423 mm x 276 mm x 250 mm (16.7" x 10.9" x 9.8")
Weight: Net	12 kg (26.5 lbs)
Operating temperature range	0°C - 40°C (32°F - 104°F)
Storage temperature range	-20°C - 60°C (-4°F - 140°F)

System Operation	
Recommended powering solution	NXAMP4X1MK2 Powered TDcontroller: up to 2 x P8 per channel
Optional powering solution	DTDcontroller + DTDAMP4x0.7 : up to 2 x P8 per channel NXAMP4x2MK2 Powered TDcontroller: up to 4 x P8 per channel NXAMP4x4MK2 Powered TDcontroller: up to 4 x P8 per channel

P10

P10 with NEXO processing	
Frequency Response (-6 dB)	63 Hz to 20 kHz
Sensitivity 1W@1m	107 dB SPL Nominal
Peak SPL Level (1m)	136 dB Peak
Recommended Power	550 to 870 Watts / 8 Ohms
HF Dispersion (according to horn)	100°x100° (Default) - 110°x60° (with 110°x60° optional horn)
Crossover Frequency	63 Hz, 85 Hz, 120 Hz
Nominal Impedance	8Ω

Product Features	
Components	1 x Coaxial Neodymium LF 10" 8 Ohms long excursion & HF 1.7" 8 Ohms
Number of ways	2 ways passive
Connectors (Touring and TIS versions)	4 x NL4, 4 poles connectors (1 per handle + 2 at the back)
Connectors (Install version)	1 x Cable gland with 2 cores cable
Rigging points	1 x universal accessory fit on each side + 1 x on the bottom
Material	Custom made bent plywood of Baltic birch and poplar
Finish	Black or White structural paint
Front Finish (Touring version)	Magnelis® steel front grille + back mesh
Front Finish (Install and TIS versions)	UV resistant acoustic fabric fitted front grill
Height x Width x Depth	497 mm x 384 mm x 274mm (19.6" x 15.2" x 10.8")
Weight: Net	15 kg (33 lbs)
Operating temperature range	0°C - 40°C (32°F - 104°F)
Storage temperature range	-20°C - 60°C (-4°F - 140°F)

System Operation	
Recommended powering solution	NXAMP4X1MK2 Powered TDcontroller: 1 x P10 per channel
Optional powering solution	DTDcontroller + DTDAMP4x1.3 : up to 2 x P10 per channel NXAMP4x2MK2 Powered TDcontroller: up to 4 x P10 per channel NXAMP4x4MK2 Powered TDcontroller: up to 4 x P10 per channel

P12

P12 with NEXO processing	
Frequency Response (-6 dB)	60 Hz - 20 kHz
Sensitivity 1W@1m	107 dB
Peak SPL Level (1m)	138dB Peak (Passive mode) / 140dB Peak (Active mode)
Recommended Power	800 to 1270 Watts / 8 Ohms
HF Dispersion (according to flanges)	60°x60° (Default) - 90°x40° (with 90x40 flange) - 60°~100°x40° (with PS flange)
Crossover Frequency	60 Hz, 85 Hz, 120 Hz
Nominal Impedance	Active mode (8Ω LF, 8Ω HF) - Passive mode: 8Ω

Product Features	
Components	1 x Coaxial Neodymium LF 12" 8 Ohms long excursion & HF 3" 8 Ohms
Number of ways (Touring and TIS versions)	2 ways passive (2+/- P12) or 2 ways active (1+/- LF, 2+/- HF) switchable
Number of ways (Install version)	2 ways passive
Connectors (Touring and TIS versions)	4 x NL4, 4 poles connectors (1 per handle + 2 at the back)
Connectors (Install version)	1 x Cable gland with 2 cores cable
Rigging points	1 x universal accessory fit on each side + 1 x on the bottom
Material	Custom made bent plywood of Baltic birch and poplar
Finish	Black or white structural paint
Front Finish (Touring)	Steel front grille + Black mesh
Front Finish (Install and TIS versions)	Acoustic fabric fitted front grill
Height x Width x Depth	534mm x 432mm x 314mm (21.0" x 17.0" x 12.3")
Weight: Net	20 kg (44 lbs)
Operating temperature range	0°C - 40°C (32°F - 104°F)
Storage temperature range	-20°C - 60°C (-4°F - 140°F)

System Operation	
Recommended powering solution	NXAMP4X2MK2 Powered TDcontroller: up to 2 x P12 per channel
Optional powering solution	DTDcontroller + DTDAMP4x0.7 (Bridged) : 1 x P12 per channel NXAMP4x1MK2 Powered TDcontroller (Bridged): up to 2 x P12 per channel NXAMP4x4MK2 Powered TDcontroller: up to 4 x P12 per channel

P15

P15 with NEXO processing	
Frequency Response (-6 dB)	57 Hz - 20 kHz
Sensitivity 1W@1m	108 dB SPL Nominal
Peak SPL Level (1m)	139 dB Peak (Passive mode) / 141 dB Peak (Active mode)
Recommended Power	850 to 1350 Watts / 8 Ohms
HF Dispersion (according to flanges)	60°x60° (Default) - 90°x40° (with 90x40 flange) - 50°~90°x40° (with PS flange)
Crossover Frequency	57 Hz, 85 Hz, 120 Hz
Nominal Impedance	Active mode: (8 Ω LF + 8 Ω HF) / Passive mode: 8 Ω

Product Features	
Components	1 x Coaxial Neodymium LF 15" 8 Ohms long excursion & HF 3" 8 Ohms
Number of ways (Touring and TIS versions)	2 ways passive (2+/- P15) or 2 ways active (1+/- LF, 2+/- HF) switchable
Number of ways (Install version)	2 ways passive
Connectors (Touring and TIS versions)	4 x NL4, 4 poles connectors (1 per handle + 2 at the back)
Connectors (Install version)	1 x Cable gland with 2 cores cable
Rigging points	1 x universal accessory fit on each side + 1 x on the bottom
Material	Custom made bent plywood of Baltic birch and poplar
Finish	Black or white structural paint
Front Finish (Touring version)	Steel front grille + Black mesh
Front Finish (Install and TIS versions)	Acoustic fabric fitted front grill
Height x Width x Depth	600mm x 483mm x 352 mm (23.6" x 19.0" x 13.9")
Weight: Net	23 kg (51 lbs)
Operating temperature range	0°C - 40°C (32°F - 104°F)
Storage temperature range	-20°C - 60°C (-4°F - 140°F)

System Operation	
Recommended powering solution	NXAMP4x2MK2 Powered TDcontroller: up to 2 x P15 per channel
Optional powering solution	DTDcontroller + DTDAMP4x0.7 (Bridged) : 1 x P15 per channel NXAMP4x1MK2 Powered TDcontroller (Bridged): up to 2 x P15 per channel NXAMP4x4MK2 Powered TDcontroller: up to 4 x P15 per channel

P18

P18 with NEXO processing	
Frequency Response (-6 dB)	50 Hz - 20 kHz
Sensitivity 1W@1m	107 dB SPL Nominal
Peak SPL Level (1m)	140 dB Peak (Passive mode) / 142 dB Peak (Active mode)
Recommended Power	1200 to 1900 Watts / 8 Ohms
HF Dispersion (according to flanges)	60°x60° (Default) - 90°x40° (with 90x40 flange) - 50°~90°x40° (with PS flange)
Crossover Frequency	50 Hz, 85 Hz, 120 Hz
Nominal Impedance	Active mode: (8 Ω LF + 8 Ω HF) / Passive mode: 8 Ω

Product Features	
Components	1 x Coaxial Neodymium LF 18" 8 Ohms long excursion & HF 4" 8 Ohms
Number of ways (Touring and TIS versions)	2 ways passive (2+/- P18) or 2 ways active (1+/- LF, 2+/- HF) switchable
Number of ways (Install version)	2 ways passive
Connectors (Touring and TIS versions)	4 x NL4, 4 poles connectors (1 per handle + 2 at the back)
Connectors (Install version)	1 x Cable gland with 2 cores cable
Rigging points	1 x universal accessory fit on each side + 1 x on the bottom
Material	Custom made bent plywood of Baltic birch and poplar
Finish	Black or white structural paint
Front Finish (Touring version)	Steel front grille + Black mesh
Front Finish (Install and TIS versions)	Acoustic fabric fitted front grill
Height x Width x Depth	680mm x 579mm x 446 mm (26.8" x 22.8" x 17.6")
Weight: Net	33 kg (73 lbs)
Operating temperature range	0°C - 40°C (32°F - 104°F)
Storage temperature range	-20°C - 60°C (-4°F - 140°F)

System Operation	
Recommended powering solution	NXAMP4x4MK2 Powered TDcontroller: up to 3 x P18 per channel
Optional powering solution	DTDcontroller + DTDAMP4x0.7 (Bridged) : 1 x P18 per bridged channels NXAMP4x1MK2 Powered TDcontroller (Bridged): up to 2 x P18 per bridged channels NXAMP4x2MK2 Powered TDcontroller: 1 x P18 per channel

Specifications

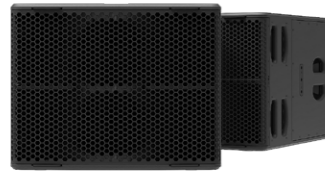

L15 sub

L15

L15 with NEXO processing
Frequency Response (-6 dB) 40 Hz - 120 Hz
Peak SPL Level (1m) 139 dB Peak
Recommended Amplifiers 850 to 1350 Watts / 4 Ohms
Crossover Frequency 85 Hz, 120 Hz
Nominal Impedance 4Ω
Product Features
Components 1x 15" – 4 ohms – Long excursion – Neodymium driver
Connectors 2x NL4, 4 poles connectors
Rigging points 1 x universal accessory fit on each side + 1 x M20 thread for Pole Stand on top
Material Custom made bent plywood of baltic birch and poplar
Finish Black or white structural paint
Front Finish Steel front grille
Height x Width x Depth 439mm x 550mm x 650 mm (17.3" x 21.7" x 25.6")
Weight 35 kg (77 lbs)
Operating temperature range 0°C - 40 °C (32° F - 104° F)
Storage temperature range -20 °C - 60 °C (-4 °F - 140° F)
System Operation
Recommended powering solution NXAMP4x2MK2 Powered TDcontroller: up to 2 x L15 per channel
Optional powering solution DTD + DTDAMP4x1.3: 1 x L15 per channel NXAMP4x1MK2 Powered TDcontroller: 1 x L15 per channel NXAMP4x4MK2 Powered TDcontroller: up to 2 x L15 per channel

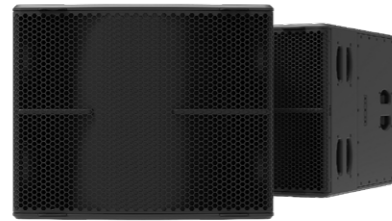

L18 sub

L18

L18 with NEXO processing
Frequency Response (-6 dB) 32 Hz - 120 Hz
Peak SPL Level (1m) 140 dB Peak
Recommended Amplifiers 1550 to 2460 Watts / 4 Ohms
Crossover Frequency 60 Hz, 85 Hz, 120 Hz
Nominal Impedance 4Ω
Product Features
Components 1 x Neodymium 18" 4 Ohms long excursion
Connectors 2 x NL4, 4 poles connectors
Rigging points 1 x universal accessory fit on each side + 1 x M20 thread for Pole Stand on top
Material Custom made bent plywood of baltic birch and poplar
Finish Black or white structural paint
Front Finish Steel front grille
Height x Width x Depth 559mm x 680mm x 775 mm (22.0" x 26.8" x 30.5")
Weight 50 kg (110 lbs)
Operating temperature range 0°C - 40 °C (32° F - 104° F)
Storage temperature range -20 °C - 60 °C (-4 °F - 140° F)
System Operation
Recommended powering solution NXAMP4x2MK2 Powered TDcontroller: 1 x L18 per channel
Optional powering solution NXAMP4x1MK2 Powered TDcontroller (Bridged): 1 x L18 per channel NXAMP4x4MK2 Powered TDcontroller: up to 2 x L18 per channel

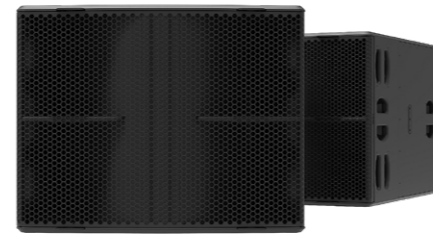

L20 sub

L20

L20 with NEXO processing
Frequency Response (-6 dB) 28 Hz - 120 Hz
Peak SPL Level (1m) 141 dB Peak
Recommended Amplifiers 2100 to 3300 Watts / 4 Ohms
Crossover Frequency 60 Hz, 85 Hz, 120 Hz
Nominal Impedance 4Ω
Product Features
Components 1 x Neodymium 20" 4 Ohms long excursion
Connectors 2 x NL4, 4 poles connectors
Rigging points 1 x universal accessory fit on each side + 1 x M20 thread for Pole Stand on top
Material Custom made bent plywood of baltic birch and poplar
Finish Black or white structural paint
Front Finish Steel front grille
Height x Width x Depth 594mm x 755mm x 905mm (23.4" x 29.7" x 35.6")
Weight 59 kg (130 lbs)
Operating temperature range 0°C - 40 °C (32° F - 104° F)
Storage temperature range -20 °C - 60 °C (-4 °F - 140° F)
System Operation
Recommended powering solution NXAMP4x4MK2 Powered TDcontroller: Up to 2 x L20 per channel
Optional powering solution NXAMP4x1MK2 Powered TDcontroller (Bridged): 1 x L20 per channel NXAMP4x2mk2 Powered TDcontroller (Bridged): 1 x L20 per channel

series

NEXO

Parc d'Activité
du Pré de la Dame Jeanne
B.P.5
60128 Plailly
FRANCE
Tel: +33 (0)3 44 99 00 70
Fax: +33 (0)3 44 99 00 30
E-mail: info@nexo.fr

